

S5700 Series Field Comm Analyzer

User Manual



This manual applies to the instruments of the following models:

- S5700A Field Comm Analyzer (CA: 2MHz - 4.4GHz, SA: 9kHz - 4.4GHz).
- S5700B Field Comm Analyzer (CA: 2MHz - 6.0GHz, SA: 9kHz - 6.0GHz).

Standard Accessories of S5700 series field comm analyzer:

No.	Item	Qty.
1	Main Machine	1 pcs
2	AC/DC Adapter	1 pcs
3	Rechargeable Li-ion Battery	1pcs
4	Vehicle Plug-in Lighter Adapter	1 pcs
5	“Y” OSL Calibration Device	1 pcs
6	1.5m Test Port Extension Cable	1 pcs
7	Soft Carrying Case	1 pcs
8	CD (Site Workbench Software and Manual)	1 pcs

Options of the S5700 series field comm analyzer:

Option No.	Item	Description
S5700-01	RF Power Meter (Software)	Providing true RMS measurements with accurate measurements for both CW and complex digitally modulated signals.
S5700-02	In-line Bi-Directional RF High Power Sensor	300 MHz to 4GHz, 2mW to 150W, N(f) 50Ω
S5700-03	Terminal RF Power Sensor	1MHz to 6GHz, -30dBm to +20dBm, N(m), 50Ω
S5700-04	Interference Location Analysis	Add Spectrogram, RSSI, Signal ID, Signal Strength, Interference Location Mapping, Delta Spectrum and DPS measurement applications to the spectrum analyzer. (Need directional log periodic antenna)
S5700-05	Signal Coverage Mapping	Allowing users to map RSSI and ACPR measurements. (Need option S5700-06)
S5700-06	GPS Module (USB)	/
S5700-07	Signal Analysis	LTE,WCDMA,TDSCDMA,GSM,CDMA
S5700-08	GPS Module (Internal Built-in)	/
S5700-09	Optical Power Meter and VFL	Using for all optical power measurements, such as optical fiber loss measurement and optical device

Option No.	Item	Description
		performance evaluation.
S5700-10	802.11 a/b/g WiFi Module	Internal Built-in
S5700-11	2-Port Transmission Measurement	Providing the capability to perform 2-port measurements.
S5700-12	Channel Scanner	/
S5700-13	Directional Active Log Periodic Antenna	Frequency range: 9 kHz to 20MHz
S5700-14	Directional Active Log Periodic Antenna	Frequency range: 20MHz to 200MHz
S5700-15	Directional Active Log Periodic Antenna	Frequency range: 200MHz to 500MHz
S5700-16	Directional Active Log Periodic Antenna	Frequency range: 500MHz to 3GHz
S5700-17	Directional Active Log Periodic Antenna	Frequency range: 500MHz to 8GHz
S5700-18	Antenna Handle with GPS and Electronics Compass	/

Preface

Thanks for choosing S5700 series field comm analyzer produced by Saluki Technology Inc. Please read this quick guide carefully for your convenience.

We devote ourselves to meeting your demands, providing you high-quality measuring instrument and the best after-sales service. We persist with “superior quality and considerate service”, and are committed to offering satisfactory products and service for our clients.

Document No.

S5700-03-01

Version

Rev01 2019.08

Saluki Technology

Authorization

The information contained in this manual is subject to change without notice. The power to interpret the contents of and terms used in this guide rests with Saluki.

Saluki Tech owns the copyright of this document which should not be modified or tampered by any organization or individual, or reproduced or transmitted for the purpose of making profit without its prior permission, otherwise Saluki will reserve the right to investigate and affix legal liability of infringement.

Product Quality Certificate

The product meets the indicator requirements of the manual at the time of delivery. Calibration and measurement are completed by the measuring organization with qualifications specified by the state, and relevant data are provided for reference.

Quality/Environment Management

Research, development, manufacturing and testing of the product comply with the requirements of the quality and environmental management system.

Contacts

Service Tel:	886.909 602 109
Website:	www.salukitec.com
Email:	sales@salukitec.com
Address:	No. 367 Fuxing N Road, Taipei 105, Taiwan (R.O.C.)

CONTENTS

Chapter 1 General Information.....	11
1.1 Overview.....	11
1.2 Standard Accessories.....	12
1.3 Available Product Measurement Options.....	12
1.4 Preventative Maintenance.....	13
1.5 ESD Caution.....	13
1.6 Battery Replacement.....	14
Chapter 2 Instrument Overview.....	15
2.1 Unpacking the Field Comm Analyzer.....	15
2.2 Powering on the Field Comm Analyzer.....	15
2.3 Exploring the Field Comm Analyzer.....	15
2.3.1 Display overview.....	15
2.3.2 Front panel overview.....	17
2.3.3 Data keypad function keys.....	18
2.3.4 Test panel connector overview.....	20
2.3.5 Symbols and indicators.....	21
2.3.6 Data Entry.....	22
2.3.7 Making a measurement.....	23
2.3.8 Measurement mode selection.....	23
2.4 About the Soft Carrying Case.....	24
Chapter 3 Calibrating the Instrument.....	25
3.1 Calibration Equipment.....	25
3.1.1 Manual and automatic calibration.....	25
3.1.2 Test port extension cable.....	26
3.2 Performing the Calibration.....	26
3.2.1 Full span calibration.....	26
3.2.2 Standard calibration.....	26
3.3 Calibration Correction and Info.....	27
Part 1 Cable Analyzer.....	28
Chapter 4 Cable Analyzer Menu.....	29

4.1 Cable & Antenna Mode: Menus & Definitions.....	31
4.1.1 Measurement menu.....	31
4.1.2 Freq/ Dist menu.....	31
4.1.3 Amplitude menu.....	33
4.1.4 Calibration menu.....	33
4.1.5 Marker menu.....	33
4.1.6 Limit menu.....	35
4.1.7 Sweep menu.....	35
4.1.8 Trace menu.....	36
4.2 Inline High Power Meter Mode: Menus & Definitions.....	37
4.2.1 Measurement menu.....	37
4.2.2 Frequency menu.....	37
4.2.3 Amplitude menu.....	38
4.2.4 Zero menu.....	38
4.2.5 Sweep menu.....	38
4.2.6 Limit menu.....	39
4.3 Terminal Power Meter Mode: Menus & Definitions.....	39
4.3.1 Frequency menu.....	39
4.3.2 Amplitude menu.....	40
4.3.3 Sweep menu.....	40
4.3.4 Limit menu.....	41
4.4 Optical Power Meter Mode: Menus & Definitions.....	41
4.4.1 Wavelength menu.....	41
4.4.2 Amplitude menu.....	41
4.4.3 Sweep menu.....	42
4.4.4 Limit menu.....	42
4.5 Visual Fault Locator (VFL) Mode: Menus & Definitions.....	43
4.6 Fiber Microscope Mode: Menus & Definitions.....	43
4.6.1 Measurement menu.....	43
4.6.2 Display menu.....	43
Chapter 5 Return Loss Measurement Testing.....	44
5.1 Setting Up a Return Loss Measurement.....	45
5.2 Making a Return Loss Measurement.....	45

Chapter 6 VSWR Measurement Testing.....	47
6.1 Setting Up a VSWR Measurement.....	48
6.2 Making a VSWR Measurement.....	48
Chapter 7 DTF Measurement Testing.....	50
7.1 Setting Up a DTF Measurement.....	51
7.2 Making a DTF Measurement.....	52
Chapter 8 One Port Cable Loss Measurement Testing.....	54
8.1 Setting Up a One Port Cable Loss Measurement.....	54
8.2 Making a One Port Cable Loss Measurement.....	55
Chapter 9 One Port Phase Measurement Testing.....	56
9.1 Setting Up a One Port Phase Measurement.....	56
9.2 Making a One Port Phase Measurement.....	57
Chapter 10 Smith Chart Measurement Testing.....	58
10.1 Setting Up a Smith Chart Measurement.....	58
10.2 Making a Smith Chart Measurement.....	59
Chapter 11 Inline High Power Meter.....	63
11.1 Making an Average Power Measurement.....	64
11.2 Making a Peak Power Measurement.....	65
11.3 Making a Burst Power Measurement.....	66
11.4 Making a CCDF Measurement.....	67
11.5 Making a Peak-to-Average Measurement.....	68
Chapter 12 Terminal Power Meter.....	70
Chapter 13 Optical Power Meter.....	72
Chapter 14 Visual Fault Locator (VFL).....	74
Chapter 15 Fiber Inspection.....	76
Chapter 16 Markers and Limit Lines.....	77
16.1 Setting a Marker.....	77
16.2 Using Limit Lines.....	78
Part 2 Spectrum Analyzer.....	80
Chapter 17 Spectrum Analyzer Menus.....	81
17.1 Spectrum Analyzer Menus & Definitions.....	82
17.1.1 Frequency menu.....	82
17.1.2 Amplitude menu (Amptd).....	83

17.1.3 Bandwidth menu (BW).....	83
17.1.4 Sweep menu (Sweep).....	84
17.1.5 Marker menu (Marker).....	85
17.1.6 Measurement setup menu (MeasSet).....	85
17.1.7 Trace menu (Trace).....	86
17.1.8 Limit menu (Limit).....	87
17.2 Spectrum Analyzer One-Button Measurement Menus.....	88
17.2.1 Channel Power.....	89
17.2.2 Occupied Bandwidth (OCC BW).....	90
17.2.3 Adjacent Channel Leakage Ratio (ACLR).....	91
17.2.4 Field Strength.....	91
17.2.5 Harmonic.....	92
Chapter 18 Spectrum Analyzer.....	93
18.1 Setting Up Spectrum Analyzer Measurements.....	94
18.1.1 Setting frequency & span parameters.....	94
18.1.2 Setting amplitude parameters.....	94
18.1.3 Setting bandwidth parameters.....	94
18.1.4 Setting sweep parameters.....	95
18.1.5 Trigger type.....	95
18.2 Additional Measurement Parameters.....	96
18.2.1 Resolution bandwidth.....	96
18.2.2 Video bandwidth.....	97
18.2.3 Sweep limitations.....	97
18.2.4 Attenuator functions.....	98
18.2.5 Detection.....	98
18.2.6 Preamplifier operation.....	99
Chapter 19 Channel Power.....	101
Chapter 20 Occupied Bandwidth (OCCBW).....	103
Chapter 21 ACLR.....	105
Chapter 22 Field Strength.....	108
Chapter 23 Harmonic.....	110
Chapter 24 Additional Field Measurements.....	111
24.1 Out-of-band Spurious Emission Measurement.....	111

24.2 In-band / Out-of-Channel Measurements.....	112
24.3 In-band Spurious Measurement.....	112
24.4 Emission Mask.....	112
Chapter 25 Spectrogram.....	115
Chapter 26 RSSI.....	117
Chapter 27 Signal Identification (SID).....	118
Chapter 28 Signal Strength.....	119
Chapter 29 Interference Location Mapping.....	120
29.1 Setting Up an Interference Location Mapping Measurement.....	121
29.2 Performing an Interference Location Mapping Measurement.....	122
29.2.1 Auto mode mapping.....	122
29.2.2 Manual mode mapping.....	123
Chapter 30 Digital Persistence Spectrum.....	126
Chapter 31 Delta Spectrum.....	128
Chapter 32 Signal Coverage Mapping.....	129
32.1 Indoor SS.....	129
32.1.1 Creating a non-GeoEmbedded map file for indoor SS measurements.....	130
32.1.2 Copying the non-GeoEmbedded map file onto the instrument’s internal memory.....	130
32.1.3 Performing an indoor SS mapping measurement.....	131
32.1.4 Saving the indoor SS mapping measurement.....	133
32.1.5 Loading the indoor SS mapping measurement.....	133
32.2 Outdoor SS.....	134
32.2.1 Creating a GeoEmbedded map file for outdoor SS measurements.....	134
32.2.2 Copying the GeoEmbedded map file onto the instrument’s internal memory.....	134
32.2.3 Performing an outdoor SS mapping measurement.....	135
32.2.4 Saving the outdoor SS mapping measurement.....	137
32.2.5 Loading the outdoor SS mapping measurement.....	137
32.2.6 Performing a drive test without a map.....	138
Chapter 33 Markers and Limit Lines.....	140
33.1 Setting a Marker.....	140
33.2 Using Limit Lines.....	141
Part 3 System.....	143
Chapter 34 File Management.....	144

34.1 Overview.....	144
34.2 Saving Files.....	145
34.2.1 Naming a File.....	145
34.2.2 File Types.....	146
34.2.3 Location.....	146
34.3 Managing Files.....	147
34.3.1 Viewing files.....	147
34.3.2 Manager tools.....	148
34.3.3 Navigation tools.....	149
Chapter 35 System Operations.....	150
35.1 System Setup.....	151
35.1.1 General System Settings.....	151
35.1.2 Display.....	151
35.1.3 Date and Time.....	152
35.1.4 Network.....	152
35.1.5 GPS.....	152
35.1.6 Touch Screen.....	153
35.1.7 Option.....	153
35.2 System Update.....	154
35.3 System Information.....	154
Chapter 36 Software Tools.....	155
36.1 Feature Overview.....	155
36.2 Installing Site Workbench.....	155
36.3 Connecting to the Field Comm Analyzer.....	155
Appendix A Creating GeoEmbedded Maps.....	157
Appendix B Creating non-GeoEmbedded Maps.....	159

Chapter 1 General Information

Introduction

This chapter provides a general description of the S5700 Series Field Comm Analyzer. Topics covered in the section include the following:

- Overview
- Standard Accessories
- Available Product Measurement Options
- Optional Accessories
- Preventative Maintenance
- ESD Caution
- Battery Replacement

1.1 Overview

The S5700A/B Field Comm Analyzer is a handheld signal analyzer that performs spectrum and RF coaxial and optical feedline measurements, aimed at simplifying the installation, maintenance and troubleshooting of a wireless site's feedline system and signal environment. The two models differ in operating frequency range.

Model	Cable Analyzer Range	Spectrum Analyzer Range
S5700A	2MHz - 4.4GHz	9kHz - 4.4GHz
S5700B	2MHz - 6.0GHz	9kHz - 6.0GHz

Base measurement functions include:

- Return Loss
- Voltage Standing Wave Ratio (VSWR)
- Distance-to-Fault (DTF)
- Cable Loss
- 1-Port Phase
- Smith Chart
- Spectrum analysis (SA) sweep
- Channel power
- Occupied bandwidth
- Adjacent Channel Leakage Ratio (ACLR)
- Field Strength
- Harmonic measurements

Additional measurement functions can be added at the time of purchase, or at the later date in the field as your test needs evolve. Software-enabled product options include RF power meters, an optical power meter, fiber inspection mode, an internal GPS receiver, interference analysis, signal coverage, and more. The GPS receiver enables the S5700 series to save location coordinates as well as measurement traces.

A bright 8.4-inch color display provides visibility even in broad daylight, while the instrument's Li-Ion battery delivers more than 6 hours of battery life. The resistive touchscreen and keypad enable users to navigate menus by touch while entering text and numbers directly.

The internal 1GB flash memory can store approximately 5,000 traces or 2,000 setup files. Measurement data and setup files can also be saved to a USB storage device or transferred to PC via LAN cable.

The SiteWorkbench companion software included makes it easy to manage, archive, and analyze current and past measurements, as well as generate and print reports. It also allows you to customize your cable, antenna, and signal standards lists.

With their lightweight, handheld design, ease of use, and rich functionality for testing RF coaxial and fiber-optic feedline and antenna systems as well as characterizing the signal environment, the S5700 series provide the field engineer's optimal test solution.

1.2 Standard Accessories

The following components are included with S5700 series field comm analyzer:

- Rechargeable Li-Ion Battery: 11.1V/5.2Ah
- AC/DC Adapter, 12.5-19 VDC
- Vehicle Plug-in Lighter Adapter
- “Y” OSL Calibration Device
- 1.5m Test Port Extension Cable
- Site Workbench Software and Documentation disc
- Soft Carrying Case

1.3 Available Product Measurement Options

Option No.	Item	Description
S5700-01	RF Power Meter (Software)	Providing true RMS measurements with accurate measurements for both CW and complex digitally modulated signals.
S5700-02	In-line Bi-Directional RF High Power Sensor	300 MHz to 4GHz, 2mW to 150W, N(f) 50Ω
S5700-03	Terminal RF Power Sensor	1MHz to 6GHz, -30dBm to +20dBm, N(m), 50Ω
S5700-04	Interference Location Analysis	Add Spectrogram, RSSI, Signal ID, Signal Strength, Interference Location Mapping, Delta Spectrum and DPS measurement applications to the spectrum analyzer. (Need directional log periodic antenna)
S5700-05	Signal Coverage Mapping	Allowing users to map RSSI and ACPR measurements. (Need option S5700-06)
S5700-06	GPS Module (USB)	/
S5700-07	Signal Analysis	LTE, WCDMA, TDSCDMA, GSM, CDMA
S5700-08	GPS Module (Internal Built-in)	/

Option No.	Item	Description
S5700-09	Optical Power Meter and VFL	Using for all optical power measurements, such as optical fiber loss measurement and optical device performance evaluation.
S5700-10	802.11 a/b/g WiFi Module	Internal Built-in
S5700-11	2-Port Transmission Measurement	Providing the capability to perform 2-port measurements.
S5700-12	Channel Scanner	/
S5700-13	Directional Active Log Periodic	Frequency range: 9 kHz to 20MHz
S5700-14	Directional Active Log Periodic	Frequency range: 20MHz to 200MHz
S5700-15	Directional Active Log Periodic	Frequency range: 200MHz to 500MHz
S5700-16	Directional Active Log Periodic	Frequency range: 500MHz to 3GHz
S5700-17	Directional Active Log Periodic	Frequency range: 500MHz to 8GHz
S5700-18	Antenna Handle with GPS and Electronics Compass	/

The software-enabled measurement options can be added at the time of purchase, or at a later date as your test needs evolve – without having to return the product to Saluki Instruments or one of its authorized service centers.

1.4 Preventative Maintenance

The S5700 series preventive maintenance consists of inspecting and cleaning the unit, all RF connectors, and all accessories. To clean the unit’s surface, use a soft, lint-free cloth dampened with water.

If necessary, the unit case can be cleaned with water and a very mild non-solvent based cleaning solution to remove dirt and light stains.

NOTE: To avoid damaging the display or instrument case, do not use solvents or abrasive cleaners.

Clean the RF connectors and center pins with a cotton swab dampened with denatured alcohol. The fingers of the N(f) connectors and the pins of the N(m) connectors should be unbroken and uniform in appearance. If you are unsure whether the connectors are damaged, gauge the connectors to confirm that the dimensions are correct. The test port cable should be uniform in appearance, and not stretched, kinked, dented, or broken.

1.5 ESD Caution

The S5700 series, like other high performance instruments, is susceptible to electrostatic discharge (ESD) damage. Coaxial cables and antennas often build up a static charge, which may damage the instrument’s input circuitry. S5700 series operators must be aware of the potential for ESD damage and take all necessary precautions.

It is recommended to discharge the static by connecting a short or load device to the cable or antenna before connecting them to S5700. It is important to remember that the operator may also carry a static charge that can cause damage. Following the practices outlined in the above standards will ensure a safe environment for both personnel and equipment.

1.6 Battery Replacement

The battery can be replaced without any tool use. The battery compartment is located on the left rear side (when the display is placed facedown). Remove the two screws, slide the cover down, and remove the battery. Installation is the opposite operation of removal.

NOTE: When inserting the battery, the battery label should face the back of the instrument and the guide slot on the battery should be below the contacts. If the battery door is not latched, the battery may be inserted incorrectly.



Fig.1.1 Battery of S5700 series

NOTE: Use only Saluki Instruments-approved batteries, adapters, and chargers provided with this instrument.

CAUTION: When using the vehicle charger, make sure that the supply is rated for a minimum of 60 watts at 12 VDC, and that the socket is clean without any dirt or debris. If the adapter plug becomes hot to the touch during charging, please discontinue use immediately.

NOTE: Saluki recommends removing the battery for long-term storage of the instrument.

Chapter 2 Instrument Overview

Introduction

This chapter describes how to get started with the S5700 series field comm analyzer. Topics covered in this section include the following:

- Unpacking the Field Comm Analyzer
- Powering on the Field Comm Analyzer
- Exploring the Field Comm Analyzer
- About the Soft Carrying Case

2.1 Unpacking the Field Comm Analyzer

Unpack and inspect the shipping package thoroughly to ensure that nothing was damaged during the shipment. Also check that your delivered package includes all of your ordered items in the shipment.

If contents in the package are damaged or defective, or if there are missing items, please contact with us.

The S5700 series should include the following items in the shipping package. For a comprehensive list of compatible accessories, see Section 1.4.

2.2 Powering on the Field Comm Analyzer

The S5700 series is capable of 4-6 hours continuous use from a fully charged battery. The instrument can also be operated from a 12 VDC source, which will simultaneously charge the battery. This can be achieved with either the AC-DC Adapter or Automotive Cigarette Lighter Adapter.

CAUTION: When using the vehicle charger, make sure that the supply is rated for a minimum of 60 watts at 12 VDC, and that the socket is clean without any dirt or debris. If the adapter plug becomes hot to the touch during charging, please discontinue use immediately.

To turn on the instrument, press and hold the On/Off button on the front panel (see diagram in Section 2.3) for approximately 2-3 seconds. The instrument will take approximately 60 seconds to complete power warm-up and load the application software. When this process is complete, the instrument is ready for use. To power the device off, press the On/Off button briefly.

In the event that the battery charge has been depleted, you will need to charge (or operate) the unit from its AC/DC adapter until the battery charge is restored to 100%.

2.3 Exploring the Field Comm Analyzer

2.3.1 Display overview

The S5700 series feature a menu-driven, touchscreen user interface that is easy to use and requires little training. Most measurement functions will employ the touchscreen UI, while other inputs will employ the front panel keypad located to the right of the display. The keypad buttons and inputs are detailed below.

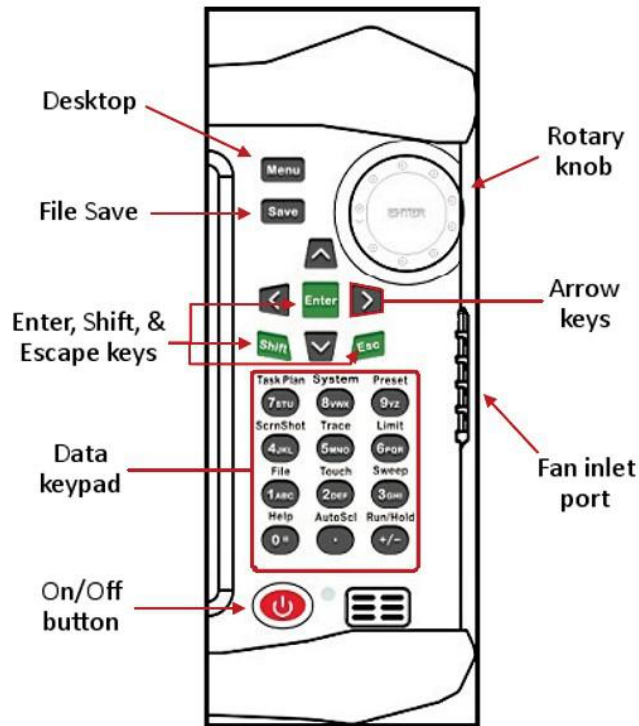

Fig.2.1 Keypad buttons of the S5700 series

The S5700 series employ a touchscreen display configured for ease of use and navigation. You can easily and quickly change measurement functions by touching either the measurement tabs located in the main menu bar (located horizontally along the bottom of the display), or the submenu functions (located along the right edge of the display). Keys displayed on the touchscreen are also referred to as softkeys.

Measurement settings are summarized along the left edge of the display. These settings can also be edited directly by touching the desired setting summary, which opens up its respective submenu or toggles a specific condition On/Off. The top row, the instrument's toolbar, features several shortcut icons that quickly and easily perform measurement tasks or simplify the operation of the instrument – for example, by expanding to full screen for better trace analysis.

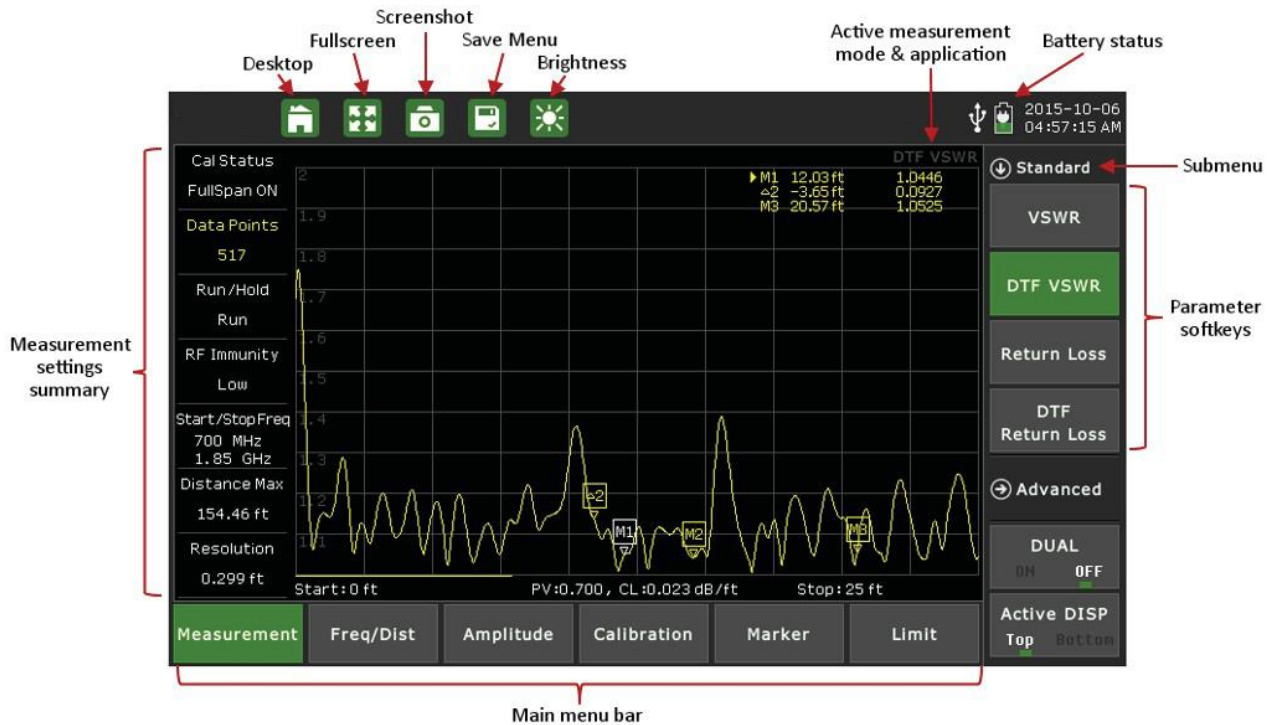

Fig.2.2 Measurement display of the S5700 series

There are six main menu keys arranged horizontally along the bottom of the touchscreen display. In Cable & Antenna measurement mode, these keys are: Measurement, Freq/Dist, Amplitude, Calibration, Marker, and Limit. The main menu function changes according to the instrument's active measurement mode: e.g., Cable Analyzer features different tools from Spectrum Analyzer.

The various measurement modes can be found by pressing the Menu key on the instrument's front panel (or by touching the desktop icon located at the top of the touchscreen display). Selecting a main menu key at the bottom of the touchscreen display will open a function-specific sub-menu.

There are up to seven submenu keys arranged vertically along the right-hand side of the touchscreen display. The submenu keys will change according to the main menu function selected, e.g. the Freq/Dist main menu contains different submenu options from the Marker main menu. The active submenu will be displayed at the top of the vertical submenu block.

2.3.2 Front panel overview

Most measurement functions will employ the touchscreen UI, while other inputs will employ the front panel keypad located to the right of the display.

The keypad includes **Menu, Save, Enter, Shift, Escape (ESC)**, and **Up/Down/Left/Right** keys, as well as a numeric data keypad. Depending on the current mode of operation, the number keys may also serve as dual-purpose measurement function keys.

Each of the dual-purpose keys is labeled with both a number and an alternate function, which is printed above the key. Simply press the numerical key to access its secondary function. When prompted for a numerical entry, the keypad will switch to entry mode.

For example, to access the Limit submenu, simply press **Limit** (#6 on the keypad). But when you wish to edit the Start Frequency of your measurement (in the Freq/Dist menu), tap the Start Freq softkey on the screen and you will be prompted for a number; pressing the 6 key now will enter the number 6.

The five main function menu keys are located to the right of the measurement display.

Menu

Pressing the Menu key opens up the desktop function and displays the Cable Analyzer measurement mode. If other measurement modes have been installed on your S5700 series, they will also be displayed on desktop. To activate a specific measurement mode, simply touch the desired measurement mode icon on the desktop: e.g., Cable Analyzer, Inline High Power Meter, etc.

Save

Pressing the Save key opens up the file save menu, enabling you to quickly label and save a measurement. File types can be saved as a measurement setup, measurement or image. File names can be quickly entered by using the pop-up touchpad. Shortcut, quick-label descriptions are also available by touching page 1 or page 2 on the pop-up keypad.

Enter

Pressing the Enter key enters the final data input, or selects a highlighted item from a list.

Shift

Pressing the Shift key and then a number key executes the function that is located above the number key.

Esc

Pressing the Esc key will cancel (escape) any setting that is currently being made, or any dialog box that is open.

Rotary Knob

Turning the rotary knob changes the numerical values, scrolls through selectable items from a list, and moves the markers left or right. Pressing the “ENTER” button at the center of the rotary knob enters data, similar to the Enter button on the keypad.

2.3.3 Data keypad function keys

When in parameter-editing mode, the data keys are active and will enter the number printed on them. Otherwise, pressing a number key executes the function that is located above the number key.

Measurement function keys are active when the instrument is not in parameter-editing mode.



Fig.2.3 Data keypad buttons

File

Pressing File (#1) opens the File submenu, enabling you to quickly label and save a measurement. Data can be saved as setup, measurement, or image files.

Touch

Pressing 2 opens the Touchscreen menu, for recalibrating the touch interface.

Sweep

Pressing Sweep (#3) opens the Sweep submenu, enabling you to set sweep type, points, RF immunity, RBW, data averaging and data smoothing.

ScrnShot

Pressing ScrnShot (#4) captures an image of the current display, saving it to internal memory as a bitmap (.bmp) file. Files are automatically named based on the measurement type.

Trace

Pressing Trace (#5) opens the Trace submenu, enabling you to view the live trace and compare to a stored trace in the memory. You can also employ the data math function to compare traces.

Limit

Pressing Limit (#6) opens the Limit submenu, enabling you to set measurement limit lines (including Pass/Fail message limit lines). An audio limit alarm can also be set to indicate that a measurement has exceeded a preset limit condition.

Task Plan

Not active in current models.

System

Pressing System (#8) opens the System submenu. In this menu, you can set various system parameters, display system info, and set system update. The system menu also allows you to change the date and time setting to your preferred format.

Preset

Pressing Preset (#9) and then tapping the “OK” softkey returns the instrument to factory settings.

Help

Pressing Help (#0) opens the Help submenu, providing context-sensitive help for main menu functions. The Help screen displays instructions according to the measurement mode that is currently active.

AutoScI

Pressing AutoScI (.) automatically adjusts the vertical measurement scale according to the measurement selected, e.g. return loss, cable loss, or spectrogram.

Run/Hold

Pressing Run/Hold (+/-) toggles the active sweep from Continuous (Run) to Single Sweep (Hold), and vice-versa. When in single sweep (Hold) mode, the sweep will start from the start frequency (or distance on the left of the display), sweep one time, and then stop at the stop frequency (or distance on the right hand side of the display) and HOLD this position until activated again. When in Hold mode, the hold symbol appears on the display.



The four **arrow keys** (around the Enter key) are used to scroll up, down, left, and right. The Up/Down arrow keys can often be used to change a value or to change a selection from a list. This function is similar to the function of the rotary knob. The **Left/Right** arrow keys can be used to move markers, while the Up/Down arrow keys can also be used to move limit lines.

LED Indicators

The Power LED is located to the right of the On/Off key. This LED is green when the unit is on.
 The Charging LED is located on the test panel. This LED is red when the battery is charging, and green when the battery is fully charged.

2.3.4 Test panel connector overview

The connectors and indicators located on the test panel are described below.

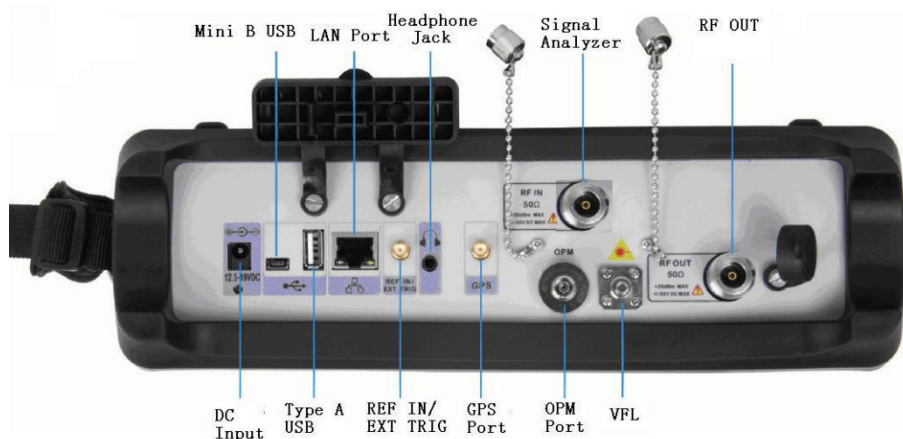

Fig.2.4 Test panel connectors

DC Input

The external power connector is used to power the unit and for battery charging. Input is 12.5 VDC to 19 VDC at up to 3.42 A. The LED on the test panel indicates that the instrument is being charged up. This LED is colored red when the battery is charging, and green when the battery is fully charged.

USB Interface - Type A

The S5700 series have a Type-A USB port that accepts USB storage devices for transferring measurements, setup files, screen images, GPS modes, and other data.

LAN port

The LAN port is used to connect the device to a PC with the SiteWorkbench software installed. This software provides a simple and easy way to manage, archive, analyze, and print measurement reports, and customize your cable list, antenna list, and signal standards list.

GPS port

With the GPS option, all measurements can be tagged and exported to geo-enabled maps for an accurate record of site locations and measurements.

RF In Signal Analyzer

50 Ω , N-Type female connector. This connector is used for spectrum and transmission measurements. Maximum input is +30 dBm at ± 50 VDC.

RF Out

50 Ω , N-Type female connector. This connector is used for Cable Analyzer reflection measurements. Maximum input +25 dBm at ± 50 VDC.

Optical Power Meter (OPM)

The OPM port features an FC connector, used with the optional Optical Power Meter (option S5700-09) mode.

VFL (Visual Fault Locator) Symbol

The VFL port features an FC connector that provides an optional light source, aiding optical fiber continuity checks and detection of spliced and/or bent fibers.

2.3.5 Symbols and indicators

The following symbols and indicators on the display indicate the instrument's current status.

Calibration Symbols

The current calibration status and type is displayed when in Cable & Antenna Analyzer mode.

➤ Calibration status **OFF**

The instrument has not been calibrated.

➤ Calibration status **Full Span ON**

The instrument has been calibrated with either Open, Short, and Load components or the electronic ECAL calibration device. When measurement frequency or sweep data points change, the calibration will remain valid.

➤ Calibration status **Standard ON**

The instrument has been calibrated with discrete Open, Short, and Load components or the electronic ECAL calibration device. If the measurement frequency exceeds the calibration frequency range, the calibration data become invalid and the instrument must be re-calibrated.

Battery Symbols



Green: Battery is 30% to 100% charged.



Yellow: Battery is 10% to 30% charged.



Red: Battery is 0% to 10% charged.



Green plug: Battery is currently charging.



Plug: Device running on external power. No battery installed.



USB connection: USB device is busy for data exchange.



GPS: did not locate successfully



GPS: has been successfully positioned

When either the AC-DC Adapter or the 12 VDC vehicle charger is connected, the battery automatically receives charge, and the battery symbol with the lightning bolt is displayed.

CAUTION: Use only Saluki-approved batteries, adapters, and chargers with this instrument.

When the instrument is connected to external power without a battery installed, the battery symbol is replaced by a plug body.

When the instrument is connected to a computer and is transferring or receiving data, the battery symbol is replaced by a USB icon.

2.3.6 Data Entry

Parameter Setting

You can set parameters with the numeric keys, the arrow keys, or the rotary knob. It is simple to change the parameters quickly with the arrow keys. You can edit a parameter continuously with the rotary knob.

Edit in position displayed

On a measurement display, many parameters are listed in place. You can move the highlight cursor at the place where a parameter appears, and press the Enter key to set it. The numeric keys, arrow keys, and rotary knob can be used to modify the parameter. Press Enter again to exit.

Submenu Entry

Upon pressing the corresponding submenu key, the parameter will appear on the upper left corner of the display. You can set the parameter using the numeric keys, arrow keys, or the rotary knob, and press Enter to exit the editor.

Text Entry

When saving a measurement, setup, or image file, you must create a filename. Use the numeric keypad to enter letters and numbers.

Changing Date and Time

To change the date and time to your desired format, press the System (#8) key on the numeric keypad. This opens the System submenu, allowing you to change the date and time. Touch “Date & Time” to the left of the display; then use the touch keyboard, including the delete/back-arrow key, to set the correct date and time.

2.3.7 Making a measurement

The S5700 series device perform various cable, antenna, power, spectrum, and signal measurements designed to simplify the installation, maintenance and troubleshooting of a wireless networking communication system.

Additional Measurement Options

The S5700’s base platform includes the Cable & Antenna and Spectrum Analysis (SA Sweep) measurement modes. Other tools can be added as software-enabled measurement options; examples follow. See Section 1.3 for a complete list.

- RF Power Meter: includes Terminal Power Meter and Inline High Power Meter.
- Optical feedline measurements: includes Optical Power Meter, Visual Fault Locator (VFL), and Fiber Inspection.
- Interference Analysis: includes Spectrogram, RSSI, SID, Signal Strength, Location, Delta Spectrum, and DPS applications.
- Signal Coverage Mapping: includes Indoor SS and Drive Test SS applications.

Additional measurement options can be added at the time of purchase, or at a later date as your test needs evolve.

2.3.8 Measurement mode selection

To perform a measurement, press the  icon on the toolbar along the top of the touchscreen display. (You can also press the Menu button to the right of the display.) This opens the S5700 desktop function and displays the Cable & Antenna and Spectrum Analyzer measurement modes.

Optional measurement modes can be installed on your S5700 at the time of purchase, or at a later date as your test needs evolve. When loaded, any optional modes and associated measurement applications will also be displayed on the desktop. Please see Section 1.3 regarding available product measurement options.

To activate a specific measurement, simply tap the desired measurement mode icon.

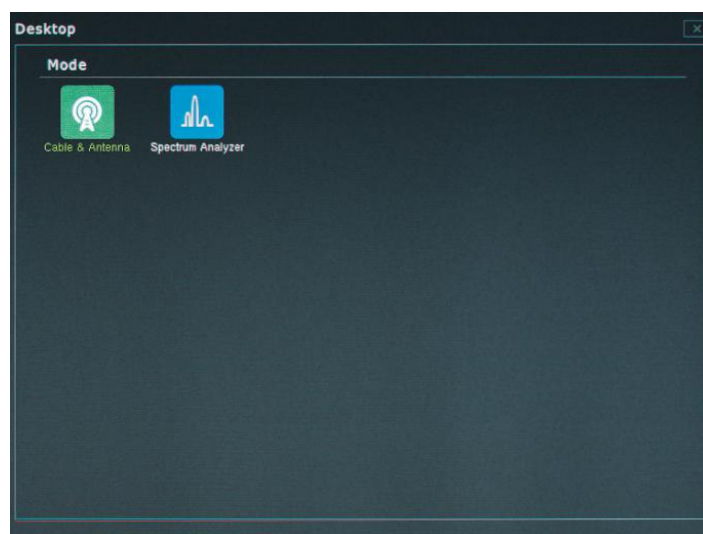

Fig.2.5 Desktop with minimal measurement modes available

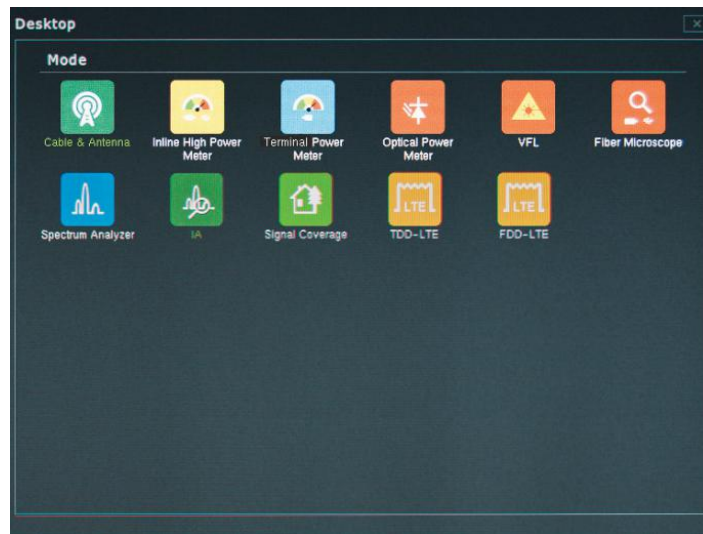

Fig.2.6 Desktop with measurement mode options enabled

2.4 About the Soft Carrying Case

The S5700 series can be operated while in the soft carrying case. On the back of the case is a large storage pouch for accessories and power supply.



Fig.2.7 Instrument inserted into the soft carrying case

To place the instrument into the soft carrying case:

1. Place the soft carrying case face-down on a stable surface, with the front panel closed and lying flat.

NOTE: The soft case has two zippers near the back. The zipper closest to the front of the case opens, enabling you to install and remove the instrument. The zipper located toward the back of the case opens an adjustable support panel that can be used to provide support for improved stability and air flow while the instrument is in the case. This support panel also contains the storage pouch.

2. Open the zippered back of the case.
3. Insert the instrument face-down into the case. Take care that the connectors fit properly through the opening in the case top.

Chapter 3 Calibrating the Instrument

Introduction

This chapter of the instrument to the Open, Short, and Load standards is important for achieving accurate, reliable cable & antenna measurement results. Measurement calibration should be performed after setting your measurement start and stop frequencies, but prior to making a cable analyzer measurement.

It is best to calibrate the instrument after turning it on and allowing approximately 10 minutes for warmup.

3.1 Calibration Equipment

3.1.1 Manual and automatic calibration

The calibration procedure requires one of the following Open, Short, Load (OSL) calibration devices:

- Mechanical “Y” OSL CAL device (manual calibration)
- Electronic eCAL OSL device (automatic calibration)

Please select the device and method that best suit your measurement needs.

Manual Calibration

Using the mechanical “Y” OSL CAL device optimizes calibration accuracy and measurement results.

This method requires that you connect the “Y” OSL device to the S5700 series and follow a short series of prompts as displayed on the screen, as well as periodically rotating the “Y” calibration device through the Open, Short, and Load positions.

Automatic Calibration

The electronic eCAL OSL device offers a quick, automatic solution to the calibration process. Measurement results may suffer some accuracy loss compared to those recorded after a manual calibration.

This method requires that you connect the eCAL OSL device to the S5700 series in both the RF Out and USB ports (using a USB-to-mini-USB cable) and press Start CAL (located in the instrument’s Calibration sub- menu). The eCAL OSL device will automatically cycle through the Open, Short, and Load positions.

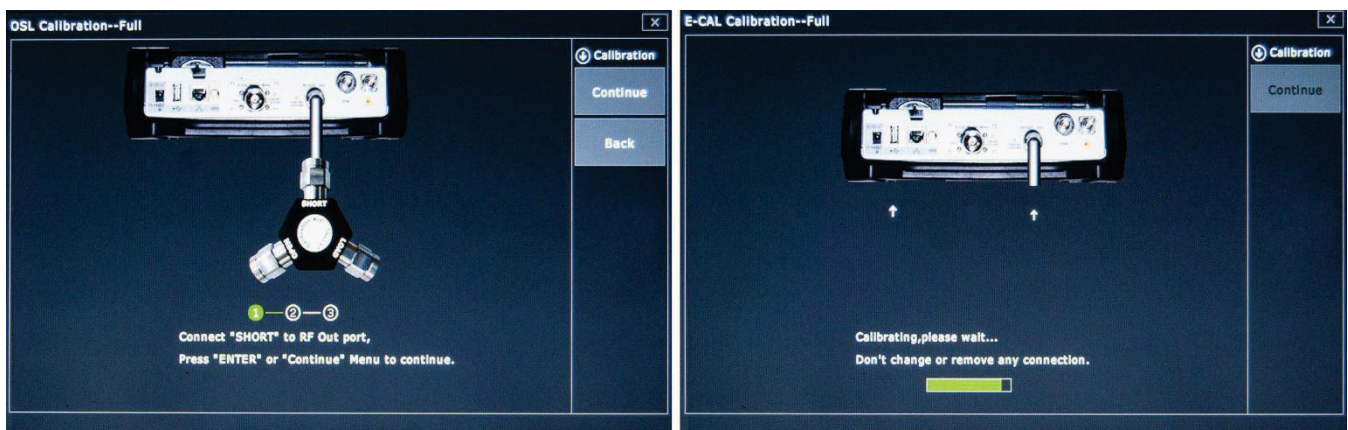

Fig.3.1 Manual calibration (left) and Automatic calibration (right)

3.1.2 Test port extension cable

Although the S5700 cable analyzer can connect directly to feedline and antenna equipment for testing, in some cell site configurations this can be difficult or unsafe. For this reason, many sweep test applications require the use of a test port extension cable.

NOTE: In the absence of a test port extension cable, a compatible cable with similar phase stability can be used without negatively impacting measurement results.

When using a test port extension cable, please note that you must calibrate at the end of the cable prior to making a measurement, or any time you disconnect and reconnect the cable.

3.2 Performing the Calibration

Once you have selected a calibration method according to Section 3.1, select a type of calibration to perform. In general, it is recommended to choose Standard CAL if you plan on measuring only within a given frequency range; choose Full Span if you plan on measuring within several different frequency ranges and modes.

See the procedure for each type in the subsections below.

3.2.1 Full span calibration

With the Full Span CAL mode, calibration is performed across the entire frequency range of the instrument. Following a full span calibration, you may freely change measurement mode and frequency range without the need to re-calibrate the instrument between operations.

Procedure:

1. Tap the **Calibration** main menu key to open the Calibration submenu.
2. Tap **Cal Method** to toggle between **OSL** (manual) and **E-CAL** (automatic); select the method that corresponds to the calibration device in use. For more details, see Section 3.1.
3. If you selected **OSL** in step 2, toggle **Cal Type** to **Full**.
4. Tap **Start Cal** to begin calibration. Follow the on-screen prompts.

Following a successful full span calibration, “FullSpan Cal ON” will appear in the calibration status tab on the left edge of the display. You may now proceed with measurement operations as needed.

When the instrument is shut down or the test cable is removed, the full span calibration will no longer be valid. “CAL OFF” will appear in the calibration status tab.

3.2.2 Standard calibration

With the Standard CAL mode, calibration is performed only within the frequency range you have defined for your measurement. The standard calibration will apply to all measurement modes, provided that the frequency range in use does not exceed the previously calibrated frequency range.

NOTE: If the new frequency range is the same as the one for which the instrument was calibrated, the calibration will remain valid. For best test results, keep the new range as close as possible to the old.

Procedure:

1. Tap the **Calibration** main menu key to open the Calibration submenu.

2. Tap **Cal Method** to toggle between **OSL** (manual) and **E-CAL** (automatic); select the method that corresponds to the calibration device in use. For more details, see Section 3.1.
3. If you selected **OSL** in step 2, toggle **Cal Type** to **STD**.
4. Tap **Start Cal** to begin calibration. Follow the on-screen prompts.

Following a successful full span calibration, “Standard ON” will appear in the calibration status tab on the left edge of the display. You may now proceed with measurement operations as needed.

When the instrument is shut down or the test port extension cable disconnected, the full span calibration will no longer be valid. “CAL OFF” will appear in the calibration status tab.

3.3 Calibration Correction and Info

The Calibration Correction tool is located in the **Calibration** main menu. Tap **Cal Correct** to turn this function **On** or **Off**. When set to Off, the current calibration status will be saved and temporarily disabled. You will be able to view your measurement without the calibration’s adjustments. The calibration will remain valid, and does not need to be repeated; simply toggle Cal Correct to On to re-apply it.

Finally, tap the **Cal Info** softkey to open the information dialog. This screen displays the current instrument settings and active calibration details, including frequency range, calibration type and method, date of the last calibration, device temperature, and temperature range within which the current calibration will remain valid.

Part 1

Cable Analyzer

Chapter 4 Cable Analyzer Menu

This chapter contains maps and descriptions of the S5700 series cable analyzer menus. Main menus are located along the bottom edge of the display and can be tapped to enter their respective submenus.

Submenus are located along the right edge of the display, and are listed in the order they appear.

Main menus are indicated with **bold text**. Submenus are indicated with an arrow. “>” indicates a closed (sub)menu.

“V” indicates an open (sub)menu, with its contents (with default values) listed below.

Cable & Antenna Mode Menus

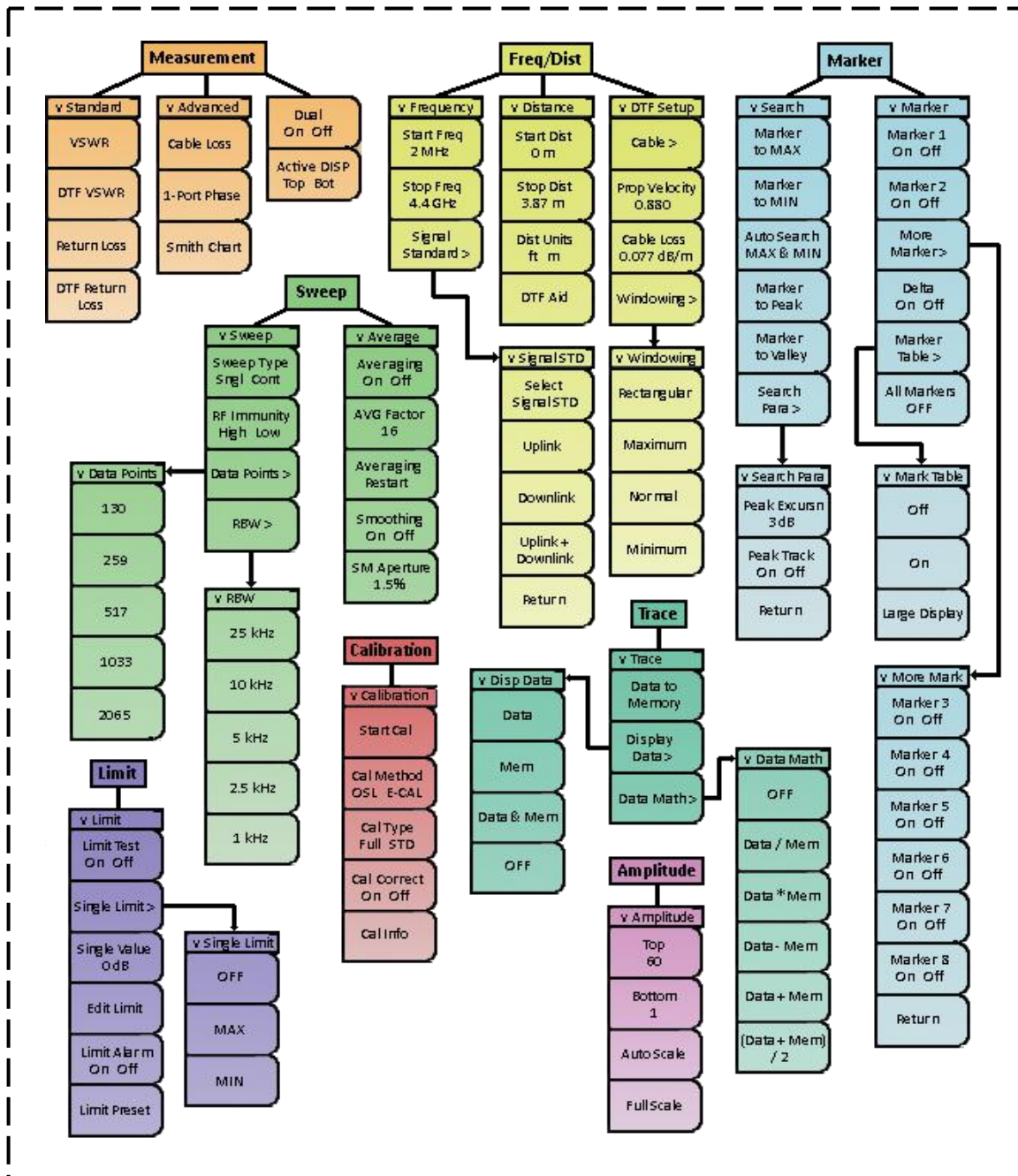

Inline High Power Meter Mode Menus

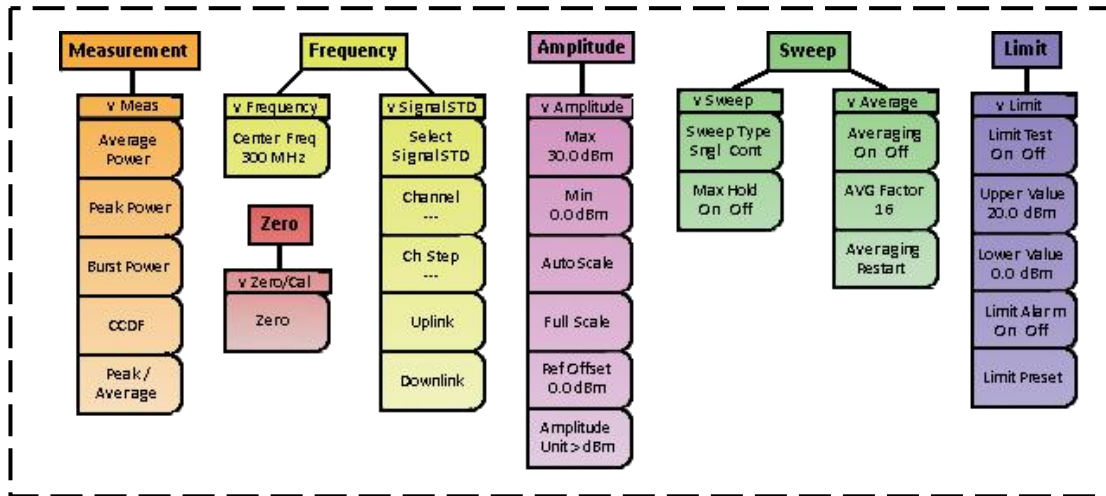

Terminal Power Meter Mode Menus

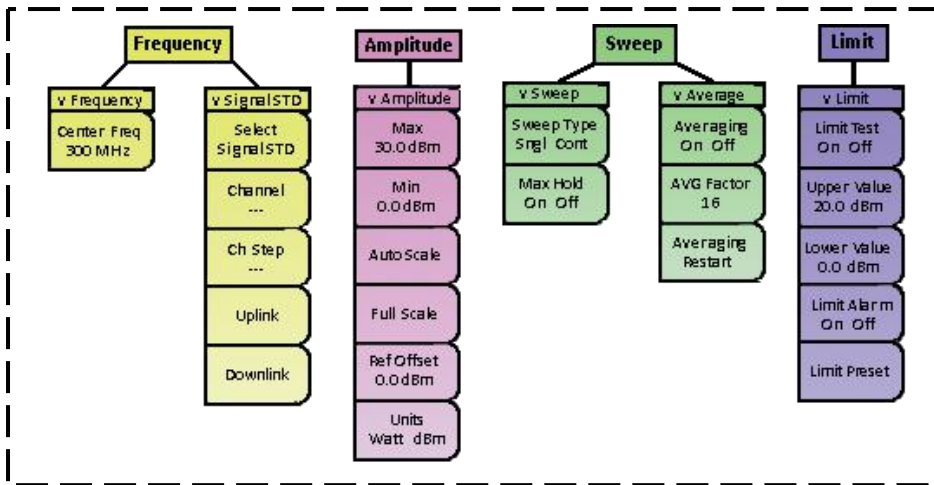

VFL Main Menu

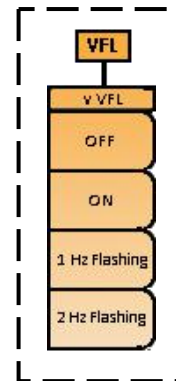

Optical Power Meter Mode Menus

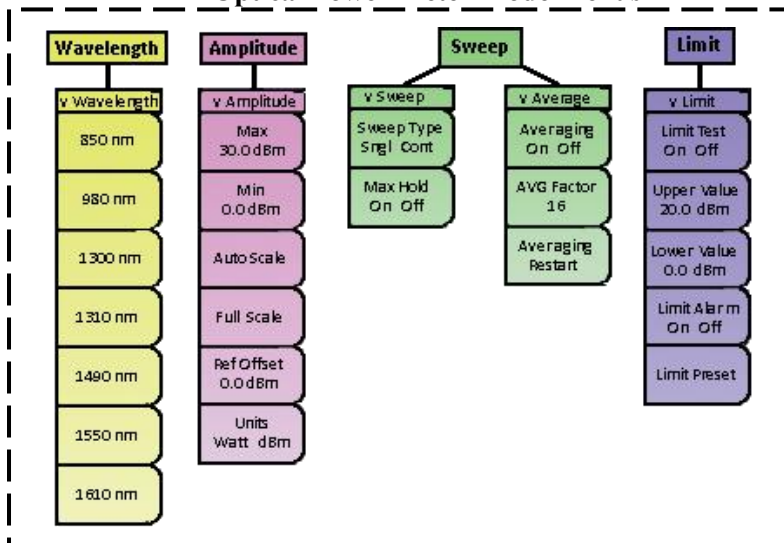

Fiber Scope Main Menu

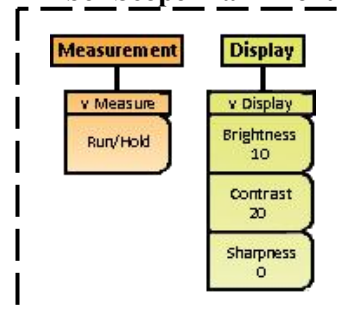

4.1 Cable & Antenna Mode: Menus & Definitions

This section defines the Cable & Antenna measurement mode’s menus and functions. Subsections 4.1.1 through 4.1.8 highlight the main menus available in this mode (Measurement, Freq/Dist, Amplitude, Calibration, Marker, Limit, Sweep, and Trace), along with their corresponding submenus.

For information on shortcut menus (those denoted on the data keypad as secondary functions), please refer to Section 4.6.

4.1.1 Measurement menu

The **Measurement main menu** contains cable & antenna measurement applications, including Return Loss, VSWR, and Distance-to-Fault.

	<p>Standard: Opens and closes the Standard measurements submenu.</p> <p>Advanced: Opens and closes the Advanced measurements submenu.</p> <p>Dual: Tap to toggle dual view On or Off. In dual view, you can view two different Cable & Antenna measurements at the same time; the display will split horizontally, showing one measurement on top and one on bottom. Toggle Off to return to the single measurement view.</p> <p>Active DISP: Tap to toggle between managing the top-displayed measurement and the bottom-displayed measurement. In dual view, the active measurement is outlined in white. When activating a new measurement from the Standard or Advanced submenus, the change will only affect the currently active measurement display. (You can toggle between your two measurements even when Dual is set to Off.)</p>
---	--

	<p>Standard Measurements Submenu</p> <p>VSWR: Activates the Voltage Standing Wave Ratio measurement. See Chapter 6 for details.</p> <p>DTF VSWR: Activates the Distance-to-Fault VSWR measurement. See Chapter 7 for details.</p> <p>Return Loss: Activates the Return Loss measurement. See Chapter 5 for details.</p> <p>DTF Return Loss: Activates the Distance-to-Fault Return Loss measurement. See Chapter 7 for details.</p>
---	--

	<p>Advanced Measurements Submenu</p> <p>Cable Loss: Activates the One Port Cable Loss measurement. See Chapter 8 for details.</p> <p>1-Port Phase: Activates the One Port Phase measurement. See Chapter 9 for details.</p> <p>Smith Chart: Activates the Smith Chart measurement. See Chapter 10 for details.</p>
---	--

4.1.2 Freq/ Dist menu

The **Frequency and Distance main menu** contains frequency range and signal standard parameters, as well as distance-to-fault measurement options.

v Frequency	Frequency Submenu
Start Freq 2 MHz	Start Freq: Sets the start frequency of the current measurement. Use the arrow keys, rotary knob, or data keypad to input a value. If prompted, tap to select a unit (Hz, kHz, MHz or GHz).
Stop Freq 4.4 GHz	Stop Freq: Sets the stop frequency of the current measurement. Use the arrow keys, rotary knob, or data keypad to input a value. If prompted, tap to select a unit (Hz, kHz, MHz or GHz).
Signal Standard >	Signal Standard: Opens and closes the Signal Standard submenu. (See next table.)

v Signal STD	Signal Standard Submenu
Select Signal STD	Select Signal STD: Opens the Signal Standard selection dialog: a list of commonly-used signal standards and their frequency ranges. Select standards using the arrow keys or rotary knob, then tap the Select/Deselect softkey to place a star (*) next to them. You can view only starred signals by toggling Display from All to Slted . Tap Search to search for a given standard by name, using the data keypad. If a USB storage device is connected to the instrument, you can also transfer saved signal standard settings to and from USB. Press the Esc button to exit the dialog.
Uplink	Uplink: Tap to indicate a signal being transmitted to the antenna.
Downlink	Downlink: Tap to indicate a signal being received at the cell tower.
Uplink + Downlink	Uplink + Downlink: Tap to indicate both uplink and downlink signals.
Return	Return: Tap to return to the Freq/Dist main menu.

v Distance	Distance Submenu
Start Dist 0 m	Start Dist: Sets how far down the cable to start the measurement. Use the arrow keys, rotary knob, or data keypad to input a value. If prompted, tap to select a unit (Hz, kHz, MHz or GHz).
Stop Dist 3.87 m	Stop Freq: Sets how far down the cable to stop the measurement. Use the arrow keys, rotary knob, or data keypad to input a value. If prompted, tap to select a unit (Hz, kHz, MHz or GHz).
Dist Units ft m	Dist Units: Tap to toggle the default distance unit between feet (ft) and meters (m).
DTF Aid	DTF Aid: Opens the DTF Aid screen. Here you can find information and helpful tips for Distance- to-Fault measurements, as well as the current status of all DTF-related parameters. Double-tap one of the tabs on the left side of the display to change its value or see advice on best settings. Press the Esc button to cancel editing a value. Press Esc again to exit DTF Aid.

v DTF Setup	DTF Setup Submenu
Cable >	Cable: Opens the Cable selection dialog: a list of commonly-used cables and their prop velocity and cable loss per foot at various frequencies. Select cables using the arrow keys or rotary knob, then tap the Select/Deselect softkey to place a star (*) next to them. You can view only starred signals by toggling Display from All to Slted . Tap Search to search for a given cable by name, using the data keypad. If a USB storage device is connected to the instrument, you can also transfer saved cable settings to and from USB. Press the Esc button to exit the dialog.
Prop Velocity 0.880	Prop Velocity: Inputs the cable propagation velocity of the cable used in your measurement.
Cable Loss 0.077 dB/m	Cable Loss: Inputs the cable loss of the cable used in your measurement.
Windowing >	Windowing: Opens the Windowing submenu. (See next table.)

v Windowing	Windowing submenu
Rectangular	Rectangular: Adjusts measurement view to maximize both peak resolution and side-lobe levels.
Maximum	Maximum: Adjusts measurement view to show somewhat lower peak resolution and side-lobe levels than Rectangular windowing.
Normal	Normal: Adjusts measurement view to show somewhat higher peak resolution and side-lobe levels than Minimum windowing.
Minimum	Minimum: Adjusts measurement view to minimize both peak resolution and side-lobe levels.

4.1.3 Amplitude menu

The **Amplitude main menu** contains amplitude and scaling parameters.

v Amplitude	Amplitude Menu
Top 60	Top: Sets the amplitude level at the top of the measurement display, in dB.
Bottom 1	Bottom: Sets the amplitude level at the bottom of the measurement display, in dB.
Auto Scale	Auto Scale: Automatically adjusts the scale to recommended range for the current measurement.
Full Scale	Full Scale: Automatically adjusts the scale to maximum range for the current measurement.

4.1.4 Calibration menu

The **Calibration main menu** allows the user to calibrate the S5700A/B analyzer when either a “Y” OSL CAL or eCAL device is connected to the instrument. You can also view or set calibration options here.

v Calibration	Calibration Menu
Start Cal	Start Cal: Initiates the calibration process. See Chapter 3 for more information on this procedure and compatible calibration devices.
Cal Method OSL E-CAL	Cal Method: Tap to toggle between calibration methods, dependent on the connected device.
Cal Type Full STD	Cal Type: Tap to toggle between Full Span and Standard calibration. See Section 3.2.
Cal Correct On Off	Cal Correct: Tap to toggle the Calibration Correct function On/Off . Calibrate your instrument, then toggle this function Off to view your measurement without the calibration’s adjustments. Even when Off, the calibration will remain valid; toggle On to re-apply it.
Cal Info	Cal Info: Opens the Calibration Info screen. This screen displays the current instrument settings and active calibration details.

4.1.5 Marker menu

The **Marker main menu** contains various tools for activating, setting, and moving up to eight markers on the measurement display. For more information, see Section 16.1.

	Marker Submenu	
		Marker 1: Tap to turn Marker 1 On/Off . Toggling On also makes this the active marker.
		Marker 2: Tap to turn Marker 2 On/Off . Toggling On also makes this the active marker.
		More Marker: Opens a submenu containing On/Off controls for Markers 3 through 8.
		Delta: Tap to toggle delta markers On/Off . When On, a delta marker corresponding to the active normal marker is created. When the delta marker is set, it becomes the reference position of the normal marker; the marker's X and Y values display the difference between the markers' positions.
		Marker Table: Opens the Marker Table submenu. (See next table.)
		All Markers OFF: Hides all currently placed markers from view. Their places are recorded; turn a marker back on and it will reappear at its previous position.

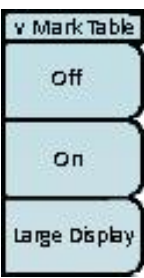
	Mark Table Submenu	
		Off: Tap to hide the Marker Table.
		On: Tap to display the Marker Table. A table of all placed markers will pop up below the measurement display, including their current numerical positions, the current measurement at that spot, and their delta positions and measurements.
	Large Display: Tap to display the active marker's numerical position and measurement in large, easily-visible type.	

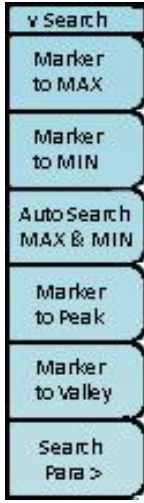
	Search Submenu	
		Marker to MAX: Moves the active marker to the location of current highest amplitude.
		Marker to MIN: Moves the active marker to the location of current lowest amplitude.
		Auto Search MAX & MIN: Searches the current measurement, and moves the active marker to highest and lowest amplitudes. Edit sensitivity of this function by setting Fault Threshold . (See next table.)
		Marker to Peak: Moves the active marker to the next (to right) peak in the measurement trace.
		Marker to Valley: Moves the active marker to the next (to right) valley in the measurement trace.
		Search Para: Opens the Search Para submenu. (See next table.)

	Search Para Submenu	
		Peak Excursion: Modifies how large a spike in the measurement trace must be before the instrument interprets it as a peak.
		Fault Threshold: Modifies how large a peak must be before the instrument interprets it as a potential fault point.
		Peak Track: Tap to toggle the Peak Track function On/Off . When on, the current active marker will automatically move to follow the highest point on the measurement trace.
	Return: Tap to return to the Marker main menu.	

4.1.6 Limit menu

The **Limit main menu** contains various tools for activating and setting up to ten upper or lower limit lines on the measurement display. For more information, see Section 16.2.

	Limit Submenu	
		Limit Test: Tap to toggle the Limit Test function On/Off . When On, the instrument will compare the current measurement to user-defined limit lines. If the measurement breaches a limit line, the text “FAIL” will appear in large red text, and the exceeding region will be colored red.
		Single Limit: Opens the Single Limit submenu. (See next table.)
		Single Value: Sets the position of the single upper or lower limit line specified in the Single Limit submenu. (See next table.)
		Edit Limit: Opens the Edit Limit dialog. Here, you can freely add, define, and delete a maximum of 10 limit lines.
		Limit Alarm: Tap to toggle the Limit Alarm feature On/Off . When on, the instrument will emit a series of beeps to notify the user when a limit line is breached.
		Limit Preset: Resets to default settings; turns all limits off.

	Single Limit Submenu	
		OFF: Tap to deactivate the default limit line.
		MAX: Tap to set an upper limit. If the measurement goes higher than the limit, "FAIL" is displayed. MIN: Tap to set a lower limit. If the measurement goes lower than the limit, "FAIL" is displayed.

4.1.7 Sweep menu

Access the Sweep menu by pressing the **Sweep (#3)** key on the data keypad to the right of the display. The **Sweep menu** allows the user to set the sweep type, speed, resolution, and various averaging functions.

	Sweep Submenu	
		Sweep Type: Tap to toggle between Single , where the instrument will perform a single sweep and then pause, and Continuous , where the instrument will initiate a new sweep as soon as the previous sweep is completed.
		RF Immunity: Tap to toggle the degree to which the instrument will reject RF interference in its measurement. Choose High or Low , depending upon the needs of your measurement.
		Data Points: Opens a submenu for setting the number of data points in the measurement: 130, 259, 517, 1033, or 2065. The default setting is 259 points. If your measurement involves a wide frequency range and/or high accuracy (e.g., a DTF test), more data points are recommended. Be aware that the larger the number of data points, the longer the instrument will take to conduct a sweep.
	RBW: Opens a submenu for setting the resolution bandwidth in the measurement. You may choose 1, 2.5, 5, 10, or 25 kHz. The default setting is 2.5 kHz.	

	Average Submenu	
		Averaging: Tap to toggle the averaging function On/Off . When On, the measurement acquires additional samples at each frequency (or power) point and performs the averaging process. Since this lessens the time between sample acquisitions, averaging is best for removing high rate noise.
		Averaging (AVG) Factor: Sets the number of measurements performed at each frequency point when averaging is On, from 1 - 999. The default value is 16.
		Averaging Restart: Tap to restart the collection and per-point averaging of measurement data.
		Smoothing: Tap to toggle the trace smoothing function On/Off . Trace smoothing performs a weighted averaging around each frequency point. Note that, since this process combines data at different frequency points, it can remove valid measurement data and should be used with care.
		Smoothing (SM) Aperture: Sets the magnitude of the smoothing function, from 0.1%–20%.

4.1.8 Trace menu

Access the Trace menu by pressing the **Trace (#5)** key on the data keypad to the right of the display. The **Trace menu** allows the user to compare the current measurement trace to a trace saved to the instrument’s internal memory, performing a variety of mathematical comparison functions.

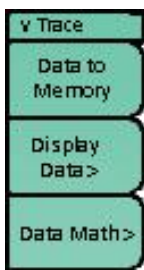
	Trace Menu	
		Data to Memory: Records the current measurement trace into the “Mem” slot in the instrument’s internal memory. Any trace comparisons from this point will be between the new trace and the one recorded as “Mem”.
		Display Data: Opens the Display Data submenu.
	Data Math: Opens the Data Math submenu.	

	Display Data Submenu	
		Data: Tap to show the current measurement trace (in yellow) on the display.
		Mem: Tap to show the saved measurement trace (in blue) on the display.
		Data & Mem: Tap to show the current and saved measurement traces simultaneously.
	OFF: Tap to turn off all measurement traces, leaving a blank grid.	

<div style="border: 1px solid black; padding: 2px; margin-bottom: 2px;">v Data Math</div> <div style="border: 1px solid black; padding: 2px; margin-bottom: 2px;">OFF</div> <div style="border: 1px solid black; padding: 2px; margin-bottom: 2px;">Data / Mem</div> <div style="border: 1px solid black; padding: 2px; margin-bottom: 2px;">Data * Mem</div> <div style="border: 1px solid black; padding: 2px; margin-bottom: 2px;">Data - Mem</div> <div style="border: 1px solid black; padding: 2px; margin-bottom: 2px;">Data + Mem</div> <div style="border: 1px solid black; padding: 2px;">(Data + Mem) / 2</div>	<p>Data Math Submenu</p> <p>OFF: Tap to disable the activated Data Math function.</p> <p>Data / Mem: Shows the quotient of the current trace divided by the saved trace.</p> <p>Data * Mem: Shows the product of the current trace multiplied by the saved trace.</p> <p>Data - Mem: Shows the difference of the saved trace subtracted from the current trace.</p> <p>Data + Mem: Shows the sum of the current trace added to the saved trace.</p>
--	---

4.2 Inline High Power Meter Mode: Menus & Definitions

This section defines the Inline High Power Meter measurement mode’s menus and functions. Subsections 4.2.1 through 4.2.6 highlight the main menus available in this mode (Measurement, Frequency, Amplitude, Zero, Sweep, and Limit), along with their corresponding submenus. The external power sensor (option S5700-02) is necessary for effective use of this measurement mode.

4.2.1 Measurement menu

The **Measurement main menu** contains the high power measurement settings, including average power, burst power, and Complementary Cumulative Distribution Function (CCDF).

<div style="border: 1px solid black; padding: 2px; margin-bottom: 2px;">v Meas</div> <div style="border: 1px solid black; padding: 2px; margin-bottom: 2px;">Average Power</div> <div style="border: 1px solid black; padding: 2px; margin-bottom: 2px;">Peak Power</div> <div style="border: 1px solid black; padding: 2px; margin-bottom: 2px;">Burst Power</div> <div style="border: 1px solid black; padding: 2px; margin-bottom: 2px;">CCDF</div> <div style="border: 1px solid black; padding: 2px;">Peak / Average</div>	<p>Measurement Menu</p> <p>Average Power: Depicts the mean power reading calculated over several cycles, as indicated by the yellow needle on the display.</p> <p>Peak Power: Depicts the maximum instantaneous power reading, as indicated by the yellow needle on the display.</p> <p>Burst Power: Depicts time-gated burst power readings and the duty cycle (the percentage of time the signal is on. E.g., for 0.5-second bursts that begin every 1.0 second, the duty cycle is 50%.)</p> <p>CCDF: Depicts the percentage of time the power reading meets or exceeds a specific power level.</p> <p>Peak / Average (PAR): Displays the ratio of the peak measured power level to the time-averaged power level.</p>
---	--

4.2.2 Frequency menu

The **Frequency main menu** contains the center frequency parameter, as well as signal standard selection.

<div style="border: 1px solid black; padding: 2px; margin-bottom: 2px;">v Frequency</div> <div style="border: 1px solid black; padding: 2px;">Center Freq 300 MHz</div>	<p>Frequency Submenu</p> <p>Center Frequency: Sets the midpoint of the frequency range for the current measurement. Input a value using the arrow keys, rotary knob, or data keypad, then select a unit (Hz, kHz, MHz or GHz).</p>
---	--

	Signal Standard Submenu	
		Select Signal STD: : Opens the Signal Standard selection dialog: a list of commonly-used signal standards and their frequency ranges. Select standards using the arrow keys or rotary knob, then tap the Select/Deselect softkey to place a star (*) next to them. You can view only starred signals by toggling Display from All to Sltd . Tap Search to search for a given standard by name, using the data keypad. If a USB storage device is connected to the instrument, you can also transfer saved signal standard settings to and from USB. Press the Esc button to exit the dialog.
		Channel: Sets a specific channel to test.
		Ch Step: Sets the channel step size. Enter “1” to test each channel one by one.
		Uplink: Tap to indicate a signal being transmitted to the antenna.
		Downlink: Tap to indicate a signal being received at the cell tower.

4.2.3 Amplitude menu

The **Amplitude main menu** contains amplitudes, scaling and reference level offset parameters.

	Amplitude Menu	
		Max: Sets the amplitude level at the top of the measurement display.
		Min: Sets the amplitude level at the bottom of the measurement display.
		Auto Scale: Automatically adjusts the scale to recommended range for the current measurement.
		Full Scale: Automatically adjusts the scale to the maximum range for the current measurement.
		Ref Offset: Sets the reference level. Using the arrow keys, rotary knob, or data keypad, enter a value to compensate for the presence of external input attenuation or gain.
		Units: Tap to toggle the active amplitude unit between Watt and dBm .

4.2.4 Zero menu

The **Zero main menu** contains the Zero command, which removes system noise from the measurement.

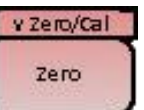
	Zero/Cal Submenu	
		Zero: Tap to perform the Zero operation, removing system noise from the measurement.

4.2.5 Sweep menu

The **Sweep menu** allows the user to set the sweep type, hold setting, and various averaging functions.

	Sweep Submenu	
		Sweep Type: Tap to toggle between Single , where the instrument will perform a single sweep and then pause, and Continuous , where the instrument will initiate a new sweep as soon as the previous sweep is completed.
		Max Hold: Freezes the measurement at its highest reading so far.

	Average Submenu	
		Averaging: Tap to toggle the averaging function On/Off . When On, the measurement acquires additional samples at each frequency (or power) point and performs the averaging process. Since this lessens the time between sample acquisitions, averaging is best for removing high rate noise.
		Averaging (AVG) Factor: Sets the number of measurements performed at each frequency point when averaging is On, from 1 - 999. The default value is 16.
		Averaging Restart: Tap to restart the collection and per-point averaging of measurement data.

4.2.6 Limit menu

The **Limit main menu** contains various tools for activating and setting an upper and lower limit line on the measurement display. The area of the meter between user-defined limit lines (i.e., the “pass” region) will be colored green. For more information, see Section 16.2.

	Limit Menu	
		Limit Test: Tap to toggle the Limit Test function On/Off . When On, the instrument will compare the current measurement to user-defined limit lines. If the measurement breaches a limit line, the text “FAIL” will appear in large red text. Failing regions are colored red, and the passing region
		Upper Value: Sets the position of an upper limit line. If the measurement goes higher than the limit, "FAIL" is displayed. Set this value to 0 to turn the upper limit off.
		Lower Value: Sets the position of a lower limit line. If the measurement goes lower than the limit, "FAIL" is displayed. Set this value to 0 to turn the lower limit off.
		Limit Alarm: Tap to toggle the Limit Alarm feature On/Off . When on, the instrument will emit a series of beeps to notify the user when a limit line is breached.
		Limit Preset: Resets to default settings; turns all limits off.

4.3 Terminal Power Meter Mode: Menus & Definitions

This section defines the Terminal Power Meter measurement mode’s menus and functions. Subsections 4.3.1 through 4-3.4 highlight the main menus available in this mode (Frequency, Amplitude, Sweep, and Limit), along with their corresponding submenus.

4.3.1 Frequency menu

The **Frequency main menu** contains the center frequency parameter, as well as signal standard selection.

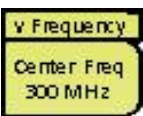
	Frequency Submenu	
		Center Frequency: Sets the midpoint of the frequency range for the current measurement. Input a value using the arrow keys, rotary knob, or data keypad, then select a unit (Hz, kHz, MHz or GHz).

	Signal Standard Submenu	
		Select Signal STD: : Opens the Signal Standard selection dialog: a list of commonly-used signal standards and their frequency ranges. Select standards using the arrow keys or rotary knob, then tap the Select/Deselect softkey to place a star (*) next to them. You can view only starred signals by toggling Display from All to Sltd . Tap Search to search for a given standard by name, using the data keypad. If a USB storage device is connected to the instrument, you can also transfer saved signal standard settings to and from USB. Press the Esc button to exit the dialog.
		Channel: Sets a specific channel to test.
		Ch Step: Sets the channel step size. Enter “1” to test each channel one by one.
		Uplink: Tap to indicate a signal being transmitted to the antenna.
	Downlink: Tap to indicate a signal being received at the cell tower.	

4.3.2 Amplitude menu

The **Amplitude main menu** contains the amplitude, scaling, and reference level offset parameters.

	Amplitude Menu	
		Max: Sets the amplitude level at the top of the measurement display.
		Min: Sets the amplitude level at the bottom of the measurement display.
		Auto Scale: Automatically adjusts the scale to recommended range for the current measurement.
		Full Scale: Automatically adjusts the scale to maximum range for the current measurement.
		Ref Offset: Sets the reference level. Using the arrow keys, rotary knob, or data keypad, enter a value to compensate for the presence of external input attenuation or gain.
	Units: Tap to toggle the active amplitude unit between Watt and dBm .	

4.3.3 Sweep menu

The **Sweep main menu** allows the user to set the sweep type, hold setting, and various averaging functions.

	Sweep Submenu	
		Sweep Type: Tap to toggle between Single , where the instrument will perform a single sweep and then pause, and Continuous , where the instrument will initiate a new sweep as soon as the previous sweep is completed.
	Max Hold: Freezes the measurement at its highest reading so far.	

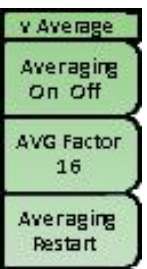
	Average Submenu	
		Averaging: Tap to toggle the averaging function On/Off . When On , the measurement acquires additional samples at each frequency (or power) point and performs the averaging process. Since this lessens the time between sample acquisitions, averaging is best for removing high rate noise.
		Averaging (AVG) Factor: Sets the number of measurements performed at each frequency point when averaging is On , from 1 - 999. The default value is 16.
	Averaging Restart: Tap to restart the collection and per-point averaging of measurement data.	

4.3.4 Limit menu

The **Limit main menu** contains various tools for activating and setting an upper and lower limit line on the measurement display. The area of the meter between user-defined limit lines (i.e., the “pass” region) will be colored green. For more information, see Section 16.2.

	<p>Limit Menu</p> <p>Limit Test: Tap to toggle the Limit Test function On/Off. When On, the instrument will compare the current measurement to user-defined limit lines. If the measurement breaches a limit line, the text “FAIL” will appear in large red text. Failing regions are colored red, and the passing region</p> <p>Upper Value: Sets the position of an upper limit line. If the measurement goes higher than the limit, "FAIL" is displayed. Set this value to 0 to turn the upper limit off.</p> <p>Lower Value: Sets the position of a lower limit line. If the measurement goes lower than the limit, "FAIL" is displayed. Set this value to 0 to turn the lower limit off.</p> <p>Limit Alarm: Tap to toggle the Limit Alarm feature On/Off. When on, the instrument will emit a series of beeps to notify the user when a limit line is breached.</p> <p>Limit Preset: Resets to default settings; turns all limits off.</p>
---	--

4.4 Optical Power Meter Mode: Menus & Definitions

This section defines the Optical Power Meter measurement mode’s menus and functions. Subsections 4.4.1 through 4.4.4 highlight the main menus available in this mode (Wavelength, Amplitude, Sweep, and Limit), along with their corresponding submenus.

4.4.1 Wavelength menu

From the **Wavelength main menu**, you can adjust the OPM’s wavelength sensitivity.

	<p>Wavelength Menu</p> <p>Wavelength: Select a value to set the wavelength at which the optical power meter will conduct measurements.</p> <p>Seven different calibrated wavelengths are available.</p>
---	---

4.4.2 Amplitude menu

The **Amplitude main menu** contains amplitudes, scaling and reference level offset parameters.

v Amplitude	
Max 30.0 dBm	Amplitude Menu
Min 0.0 dBm	Max: Sets the amplitude level at the top of the measurement display.
Auto Scale	Min: Sets the amplitude level at the bottom of the measurement display.
Full Scale	Auto Scale: Automatically adjusts the scale to recommended range for the current measurement.
Ref Offset 0.0 dBm	Full Scale: Automatically adjusts the scale to maximum range for the current measurement.
Units Watt dBm	Ref Offset: Sets the reference level. Using the arrow keys, rotary knob, or data keypad, enter a value to compensate for the presence of external input attenuation or gain.
	Units: Tap to toggle the active amplitude unit between Watt and dBm .

4.4.3 Sweep menu

The **Sweep main menu** allows the user to set the sweep type, hold setting, and various averaging functions.

v Sweep	
Sweep Type Sngl Cont	Sweep Submenu
Max Hold On Off	Sweep Type: Tap to toggle between Single , where the instrument will perform a single sweep and then pause, and Continuous , where the instrument will initiate a new sweep as soon as the previous sweep is completed.
	Max Hold: Freezes the measurement at its highest reading so far.

v Average	
Averaging On Off	Average Submenu
AVG Factor 16	Averaging: Tap to toggle the averaging function On/Off . When On, the measurement acquires additional samples at each frequency (or power) point and performs the averaging process. Since this lessens the time between sample acquisitions, averaging is best for removing high rate noise.
Averaging Restart	Averaging (AVG) Factor: Sets the number of measurements performed at each frequency point when averaging is On, from 1 - 999. The default value is 16.
	Averaging Restart: Tap to restart the collection and per-point averaging of measurement data.

4.4.4 Limit menu

The **Limit main menu** contains various tools for activating and setting an upper and lower limit line on the measurement display. The area of the meter between user-defined limit lines (i.e., the “pass” region) will be colored green. For more information, see Section 16.2.

v Limit	
Limit Test On Off	Limit Menu
Upper value 20.0 dBm	Limit Test: Tap to toggle the Limit Test function On/Off . When On, the instrument will compare the current measurement to user-defined limit lines. If the measurement breaches a limit line, the text “FAIL” will appear in large red text. Failing regions are colored red, and the passing region
Lower value 0.0 dBm	Upper Value: Sets the position of an upper limit line. If the measurement goes higher than the limit, "FAIL" is displayed. Set this value to 0 to turn the upper limit off.
Limit Alarm On Off	Lower Value: Sets the position of a lower limit line. If the measurement goes lower than the limit, "FAIL" is displayed. Set this value to 0 to turn the lower limit off.
Limit Preset	Limit Alarm: Tap to toggle the Limit Alarm feature On/Off . When on, the instrument will emit a series of beeps to notify the user when a limit line is breached.
	Limit Preset: Resets to default settings; turns all limits off.

4.5 Visual Fault Locator (VFL) Mode: Menus & Definitions

This section defines the Visual Fault Locator measurement mode’s menus and functions. Subsection 4.5.1 highlights the single main menu available in this mode (VFL).

VFL Menu

The VFL main menu contains controls for the Visual Fault Locator light beam, which is emitted from the VFL port on the instrument’s top panel. Unscrew and remove the metal cap over this port, then connect the fiber to this port to use the light.

NOTE: The beam emitted by the VFL can cause vision damage. For your safety, do not look directly at the light beam for extended periods of time.

	VFL Menu	
		OFF: Switches the fault locator light off.
		ON: Switches the fault locator light on. The light will shine continuously.
		1 Hz Flashing: The fault locator light will flash on and off at a rate of 1 flash per second. 2 Hz Flashing: The fault locator light will flash on and off at a rate of 2 flashes per second.

4.6 Fiber Microscope Mode: Menus & Definitions

This section defines the Fiber Microscope measurement mode’s menus and functions. Subsection 4.6.1 and 4.6.2 highlight the main menus available in this mode (Measurement and Display).

4.6.1 Measurement menu

The **Measurement main menu** contains a Run/Hold control for the fiber probe’s video feed.

	Measure Menu	
		Run/Hold: Tap to toggle. Hold pauses the measurement display at its current point, and Run unpauses it to continue the real-time measurement.

4.6.2 Display menu

	Display Menu	
		Brightness: Sets the brightness of the video feed. Use the arrow keys, rotary knob, or data keypad to adjust the value between -10 (dimmiest) and +10 (brightest), then press Enter to confirm.
		Contrast: Sets the light-dark contrast of the video feed. Use the arrow keys, rotary knob, or data keypad to adjust the value between 0 and 20, then press Enter to confirm.
	Sharpness: Sets the sharpness of the video feed. Use the arrow keys, rotary knob, or data keypad to adjust the value between 0 (softest) and 10 (sharpest), then press Enter to confirm.	

Chapter 5 Return Loss Measurement Testing

Introduction

This chapter provides an overview of performing **Return Loss** measurements with the S5700A/B Cable Analyzer. The Return Loss measurement is used to characterize the cable and antenna system in order to ensure that the cell site is performing in accordance with established standards.

Underperforming cell sites typically exhibit a high level of signal reflections, due to impedance mismatches within the cable and antenna system. Impedance mismatch issues often contribute to blocked or dropped calls, poor data rates, and an overall undesirable performance in cell (or section of cell) coverage. Thus, the Return Loss performance of the antenna system – included the cable feedline – is a critical factor in the service and maintenance of an RF transmitter system.

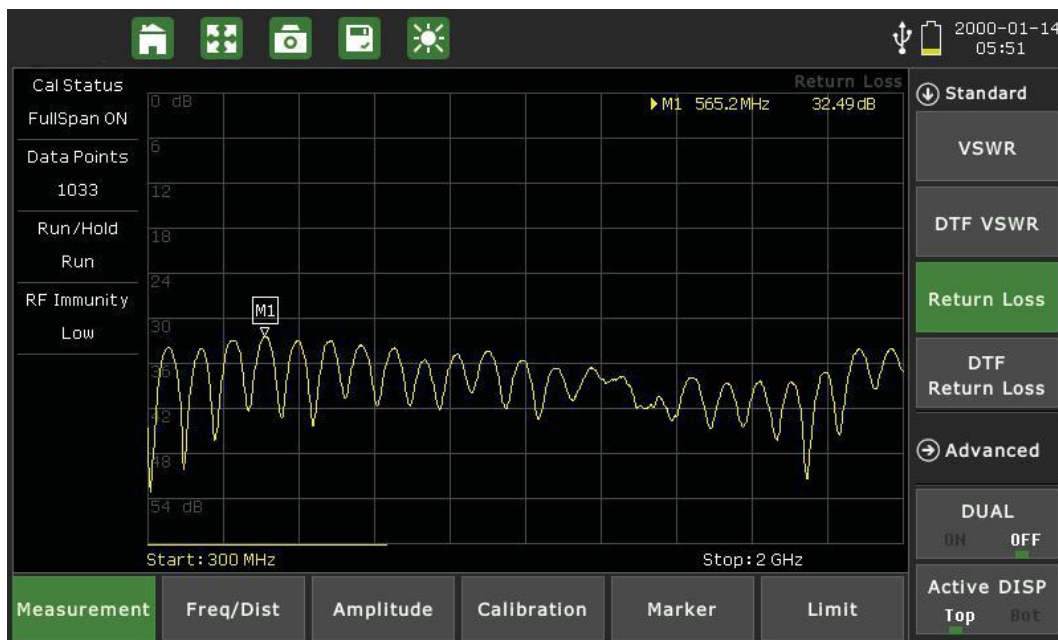

Fig.5.1 Return loss measurement interface

Return Loss and VSWR both display the match of the system, but they show it in different ways. The return loss displays the ratio of reflected power to reference power in decibels (dB). The return loss view is usually preferred because of the benefits of a logarithmic display; for one, it is easier to compare a small and large number on a logarithmic scale. The return loss scale is normally set up from 0 to 60 dB, with 0 being an open or a short and 60 dB being close to a perfect match.

Reflection measurements are generally performed with the antenna connected to the cable feedline, or by replacing the antenna with a Load at the end of the RF cable.

To begin a Return Loss measurement, press the **Menu** button to open the measurement mode desktop, then tap the **Cable & Antenna** mode icon. In the **Measurement** main menu, select Return Loss.

Which reflection measurement should I use?

Your specification (test procedure) will ordinarily direct you to make either a Return Loss or VSWR measurement.

Typically, **system sweeps** are performed in Return Loss mode, while **component sweeps** are performed in VSWR mode.

For your convenience, the S5700 series analyzer can perform Return Loss and VSWR sweeps simultaneously while in **Dual Display** mode.

NOTE: The larger of the values of the Return Loss measurement, the better the impedance match. Thus a Return Loss measurement of 42dB represents a much better impedance match than one of 25dB. Conversely, in VSWR, better impedance matches are indicated by smaller values.

5.1 Setting Up a Return Loss Measurement

The following is a step-by-step guide for preparing to conduct a return loss measurement using the S5700 series's cable analyzer function.

Procedure:

1. To set the instrument in the cable analyzer mode, press the **Menu** button to view the measurement mode desktop. Tap the **Cable & Antenna** softkey. Tap the **Measurement** main menu softkey to open the Measurement menu on the right side of the display. Under the **Standard** submenu, select **Return Loss**.

To determine which measurement is best for your needs, please refer to the Introduction of this chapter.

3. Tap the **Freq/Dist** main menu softkey. Under the **Frequency** submenu, set your desired Start and Stop frequencies. There are two ways to accomplish this.
 - a. Manually enter the desired start frequency by tapping **Start Freq** and using the arrow keys, data keypad, or rotary knob. Press Enter to confirm. Repeat for **Stop Freq**.
 - b. Open the **Signal Standard** submenu and tap **Select Signal STD**. Double-tap your preferred signal standard on the list to select it and return to the submenu, then select the signal type by tapping **Uplink**, **Downlink**, or **Uplink + Downlink**.

4. If "ON" appears under Calibration Status on the left-hand side of the display, continue to step 5. Otherwise, you will need to calibrate the instrument. See Chapter 3 — Calibrating the Instrument.

5. Tap the **Amplitude** main menu key and use the **Top** and **Bottom** softkeys to set the amplitude scale. A general guideline for best measurement results is to set Top to 0dB and Bottom to 60dB, or simply tap Full Scale.

6. Press the **Sweep (#3)** datakey to open the Sweep submenu. Tap Data Points to select the resolution of your measurement. You may choose 130, 259, 517, 1033, or 2056 data points.

The default setting is 259. The higher the setting, the longer it will take to complete a sweep.

7. In the Sweep submenu, tap RF Immunity to toggle interference rejection between High and Low depending on your measurement needs.

5.2 Making a Return Loss Measurement

Once you have set the desired parameters (as covered in Section 5.1), the instrument is ready to perform the Return Loss measurement.

Procedure:

1. Connect the antenna or cable feedline to the RF Out port on the instrument, using a test port extension cable if necessary.
2. The measurement trace will appear on the instrument display in real time.
3. For best results, allow the instrument to perform several sweeps in Continuous mode.

For details on analyzing the measurement results, please refer to Chapter 16 — Markers and Limit Lines.

Saving the Measurement:

When you have conducted a successful measurement and wish to save the results for later viewing or analysis, press the **Save** button to the top-right of the display. Return loss measurements will save as .RTL files. For more details on naming and saving files to the instrument or USB, see Section 34.2.

Chapter 6 VSWR Measurement Testing

Introduction

This chapter provides an overview of performing **Voltage Standing Wave Ratio (VSWR)** measurements with the S5700 series Signal Analyzer. Like Return Loss, VSWR is used to characterize the cable and antenna system in order to ensure that the cell site is performing in accordance with established standards.

In telecommunications, the Standing Wave Ratio (SWR) is the ratio of a partial standing wave's maximum amplitude to its minimum amplitude in an electrical transmission line. The SWR is usually defined as a Voltage ratio called the VSWR. For example, the VSWR value 1.2:1 denotes the maximum standing wave amplitude that is 1.2 times greater than the minimum standing wave value.

VSWR displays the match of the system linearly, rather than logarithmically. VSWR measures the ratio of voltage peaks and valleys. If the match is not perfect, the peaks and valleys of the returned signal will not align perfectly with the transmitted signal. The greater this number, the worse the match. A perfect or ideal match in VSWR terms would be 1:1; however, a more realistic match for a cable & antenna system would be something like 1.43 (15 dB). Antenna manufacturers typically specify the match in VSWR. The scale of a VSWR is usually defaulted to setup between 1 and 65.

Reflection measurements are generally performed with the antenna connected to the cable feedline, or by replacing the antenna with a Load at the end of the RF cable.

To begin a VSWR measurement, press the **Menu** button to open the measurement mode desktop, then tap the **Cable & Antenna** mode icon. In the **Measurement** main menu, select VSWR.

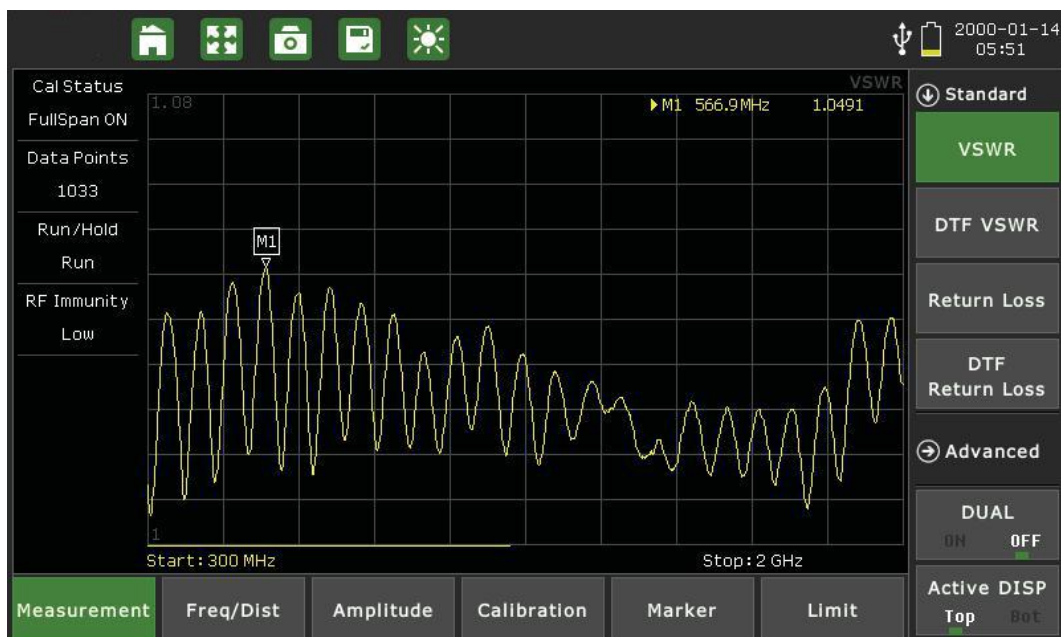

Fig.6.1 VSWR measurement interface

Which reflection measurement should I use?

Your specification (test procedure) will ordinarily direct you to make either a Return Loss or VSWR measurement.

Typically, **system sweeps** are performed in Return Loss mode, while **component sweeps** are performed in VSWR mode.

For your convenience, the S5700 series can perform Return Loss and VSWR sweeps simultaneously while in **Dual Display** mode.

NOTE: The larger of the values of the Return Loss measurement, the better the impedance match. Thus a Return Loss measurement of 42dB represents a much better impedance match than one of 25dB. Conversely, in VSWR, better impedance matches are indicated by smaller values.

6.1 Setting Up a VSWR Measurement

The following is a step-by-step guide for preparing to conduct a VSWR measurement using the S5700 series's cable analyzer function.

Procedure:

1. To set the instrument in the cable analyzer mode, press the **Menu** button to view the measurement mode desktop. Tap the **Cable & Antenna** softkey. Tap the **Measurement** main menu softkey to open the Measurement menu on the right side of the display. Under the **Standard** submenu, select **VSWR**.

To determine which measurement is best for your needs, please refer to the Introduction of this chapter.

3. Tap the **Freq/Dist** main menu softkey. Under the **Frequency** submenu, set your desired Start and Stop frequencies. There are two ways to accomplish this.
 - c. Manually enter the desired start frequency by tapping **Start Freq** and using the arrow keys, data keypad, or rotary knob. Press Enter to confirm. Repeat for **Stop Freq**.
 - d. Open the **Signal Standard** submenu and tap **Select Signal STD**. Double-tap your preferred signal standard on the list to select it and return to the submenu, then select the signal type by tapping **Uplink**, **Downlink**, or **Uplink + Downlink**.

4. If "ON" appears under Calibration Status on the left-hand side of the display, continue to step 5. Otherwise, you will need to calibrate the instrument. See Chapter 3 — Calibrating the Instrument.

5. Tap the **Amplitude** main menu key and use the **Top** and **Bottom** softkeys to set the amplitude scale. A general guideline for best measurement results is to set Top to 0dB and Bottom to 60dB, or simply tap Full Scale.

6. Press the **Sweep (#3)** datakey to open the Sweep submenu. Tap **Data Points** to select the resolution of your measurement. You may choose 130, 259, 517, 1033, or 2056 data points.

The default setting is 259. The higher the setting, the longer it will take to complete a sweep.

7. In the Sweep submenu, tap **RF Immunity** to toggle interference rejection between High and Low depending on your measurement needs.

6.2 Making a VSWR Measurement

Once you have set the desired parameters (as covered in Section 6.1), the instrument is ready to perform the VSWR measurement.

Procedure:

1. Connect the antenna or cable feedline to the RF Out port on the instrument, using a test port extension cable if necessary.
2. The measurement trace will appear on the instrument display in real time.
3. For best results, allow the instrument to perform several sweeps in Continuous mode.

For details on analyzing the measurement results, please refer to Chapter 16 — Markers and Limit Lines.

Saving the Measurement:

When you have conducted a successful measurement and wish to save the results for later viewing or analysis, press the **Save** button to the top-right of the display. Return loss measurements will save as .RTL files. For more details on naming and saving files to the instrument or USB, see Section 34.2.

Chapter 7 DTF Measurement Testing

Introduction

This chapter provides an overview of performing **Distance-to-Fault (DTF)** measurements with the S5700 series Signal Analyzer. While reflection measurements express a cell site's RF transmission efficiency, DTF measurements identify the location of a specific fault within the cable and antenna system.

Since reflection measurements verify the impedance discontinuity of the total feedline system, it is crucial to perform DTF measurements to identify the exact component degrading the line system's performance.

Here, the instrument transmits a test signal along the conductor or transmission medium. If the conductor is of uniform impedance and properly terminated, the entire transmitted signal will be absorbed in the far-end termination and no signal will be reflected toward the instrument. Any impedance discontinuities will cause some of the incident signal to be sent back towards the source.

Higher impedance creates a reflection that reinforces the original signal, while lower impedance creates a reflection that opposes the original signal. The resulting reflected signal is plotted as a function of time. In addition, because the speed of signal propagation is relatively constant for a given transmission medium, it can also be read as a function of cable length. S5700 series can verify cable impedance characteristics, splice and connector locations and associated losses, and estimate cable lengths or faulty location.

To begin a Distance-to-Fault measurement, press the **Menu** button to open the measurement mode desktop, then tap the **Cable & Antenna** mode icon. Tap the Measurement main menu key along the bottom of the display, then open the Standard submenu and choose a DTF measurement.

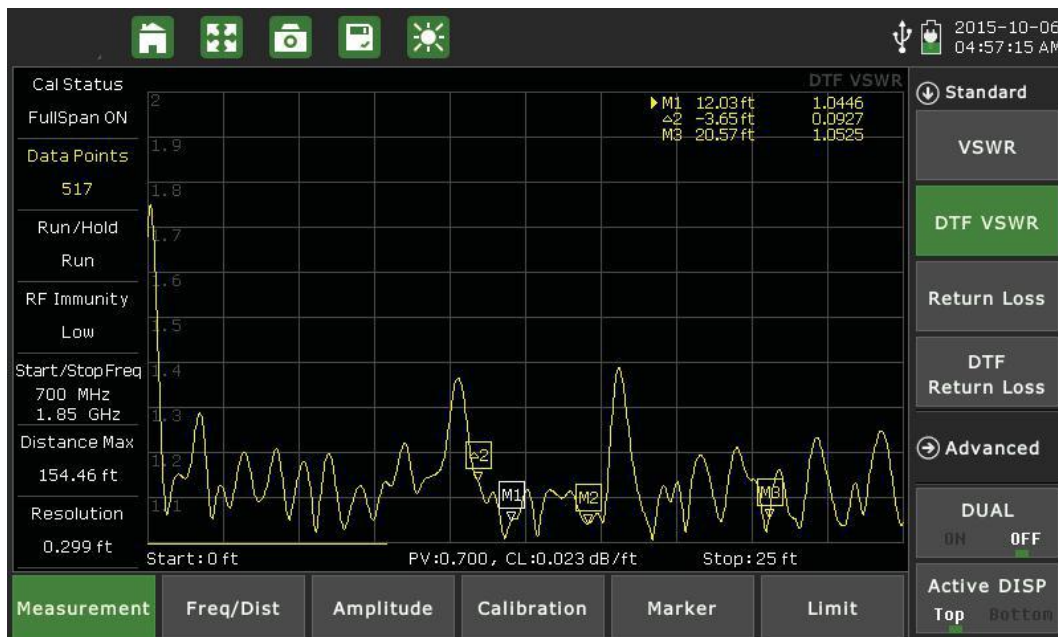

Fig. 7.1 DTF-VSWR measurement interface

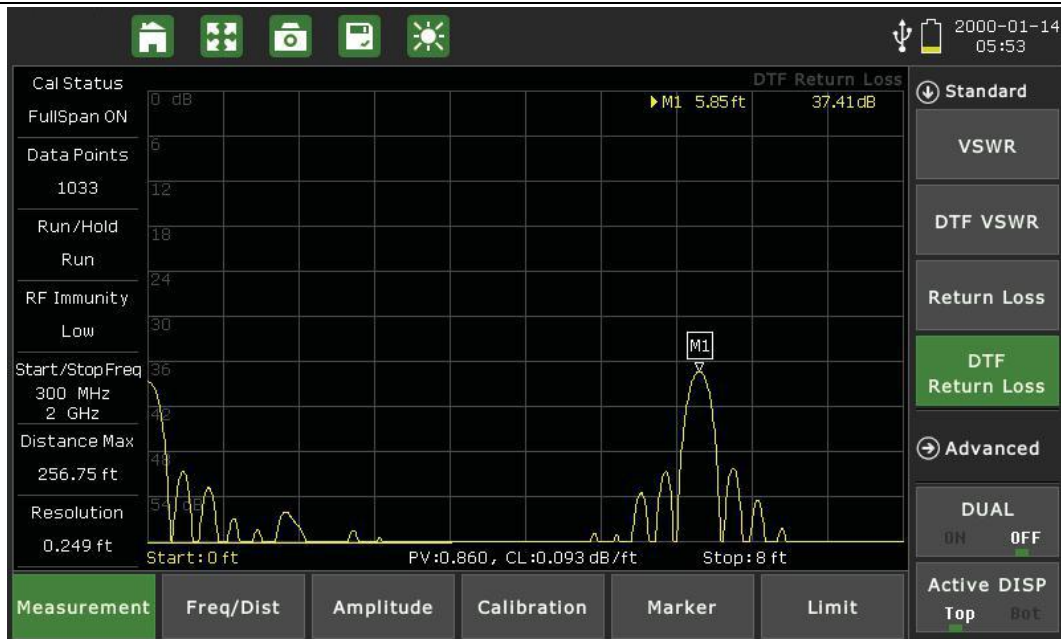

Fig.7.2 DTF return loss measurement interface

Which DTF measurement should I use?

Your specification (test procedure) will ordinarily direct you to make either a DTF Return Loss or DTF VSWR measurement. Typically, **site sweeps** are performed in DTF Return Loss mode. This is because it is easier to spot subtle differences and compare large and small values in the DTF Return Loss logarithmic display.

For your convenience, the S5700 series can perform DTF Return Loss and DTF VSWR sweeps simultaneously while in Dual Display mode.

NOTE: The larger the values of the DTF Return Loss measurement, the better the impedance match. Thus a Return Loss measurement of 42dB represents a much better impedance match than one of 25dB. Conversely, in DTF VSWR, better impedance matches are indicated by smaller values.

7.1 Setting Up a DTF Measurement

The following is a step-by-step guide for preparing to conduct a DTF measurement using the S5700 series's cable analyzer function.

Procedure:

1. To set the instrument in the cable analyzer mode, press the **Menu** button to view the measurement mode desktop. Tap the **Cable & Antenna** softkey.

2. Tap the **Measurement** main menu softkey to open the Measurement menu on the right side of the display. Under the **Standard** submenu, select either **DTF Return Loss** or **DTF VSWR**.

To determine the best measurement for your needs, see the Introduction of this chapter.

3. Tap the **Freq/Dist** main menu softkey. Under the **Frequency** submenu, set your desired Start and Stop frequencies. There are two ways to accomplish this.

- a. Manually enter the desired start frequency by tapping **Start Freq** and using the arrow keys, data keypad, or rotary knob. Press Enter to confirm. Repeat for **Stop Freq**.

b. Open the **Signal Standard** submenu and tap Select Signal STD. Double-tap your preferred signal standard on the list to select it and return to the submenu, then select the signal type by tapping Uplink, Downlink, or Uplink + Downlink.

4. For a DTF measurement, you must now specify the length of the transmission line (“distance”) and the type of cable in use. The cable type determines the propagation velocity and cable loss.

NOTE: Selecting the correct cable is vital for achieving accurate measurements and locating faults. Specifying an incorrect cable type, or setting a measurement frequency out of the cable’s range, will affect the DTF trace.

5. Still under Freq/Dist, open the **Distance** submenu. Enter the start and stop distance; be sure that you toggle Dist Units to highlight the correct unit.

6. Still under Freq/Dist, open the **DTF Setup** submenu and tap **Cable**. Double-tap your preferred cable on the list to select it and return to the DTF Setup submenu.

If you are sweeping the entire feedline (jumpers plus main feeder), use the main feedline as the cable type for your measurement.

7. If “ON” appears under Calibration Status on the left-hand side of the display, continue to step 8. Otherwise, you will need to calibrate the instrument. See Chapter 3 — Calibrating the Instrument.

8. Tap the **Amplitude** main menu key and use the **Top** and **Bottom** softkeys to set the amplitude scale. The ideal amplitude scale will differ depending on which reflection measurement you selected in step 2. Some general guidelines for best measurements results are:

- a. For DTF Return Loss, set Top to 0dB and Bottom to 60dB, or simply tap **Full Scale**.
- b. For DTF VSWR, set Top to 60dB and Bottom to 1dB, or simply tap **Full Scale** or **Auto Scale**.

9. Press the **Sweep (#3)** datakey to open the Sweep submenu. Tap **Data Points** to select the resolution of your measurement. You may choose 130, 259, 517, 1033, or 2056 data points.

The default setting is 517. The higher the setting, the longer it will take to complete a sweep.

10. In the Sweep submenu, tap **RF Immunity** to toggle interference rejection between High and Low depending on your measurement needs.

The default setting is Low. Use High when you suspect a high level of RF signal energy from neighboring cell sites, or other potential interference in the area.

7.2 Making a DTF Measurement

Once you have selected a measurement type and set the desired parameters (as covered in Section 7.1), the instrument is ready to perform the DTF measurement.

Procedure:

1. Connect the antenna or cable feedline to the RF Out port on the instrument, using a test port extension cable if necessary.
2. The measurement trace will appear on the instrument display in real time.

3. You may wish to select Single Sweep, to hold measurement data for easier analysis and saving. For details on analyzing the measurement results, please refer to Chapter 16 — Markers and Limit Lines.

Saving the Measurement:

When you have conducted a successful measurement and wish to save the results for later viewing or analysis, press the Save button to the top-right of the display. DTF return loss measurements will save as .DRL files, while DTF-VSWR measurements will save as .DVS files. For more details on naming and saving files to the instrument or USB, see Section 34.2.

Chapter 8 One Port Cable Loss Measurement Testing

Introduction

This chapter provides an overview of performing **Cable Loss** measurements with the S5700 series Signal Analyzer. The **One Port Cable Loss** measurement checks the signal attenuation level (insertion loss) of the RF cable. Excessive cable loss will negatively affect cell site coverage.

This measurement can be especially useful in measuring the loss of feed line connected to the antenna. By placing a short at the end of the cable or leaving it open, the signal is reflected back and the energy lost in the cable can be computed. Cables with larger diameter generally have less insertion loss and better power handling capabilities than cables with smaller diameter.

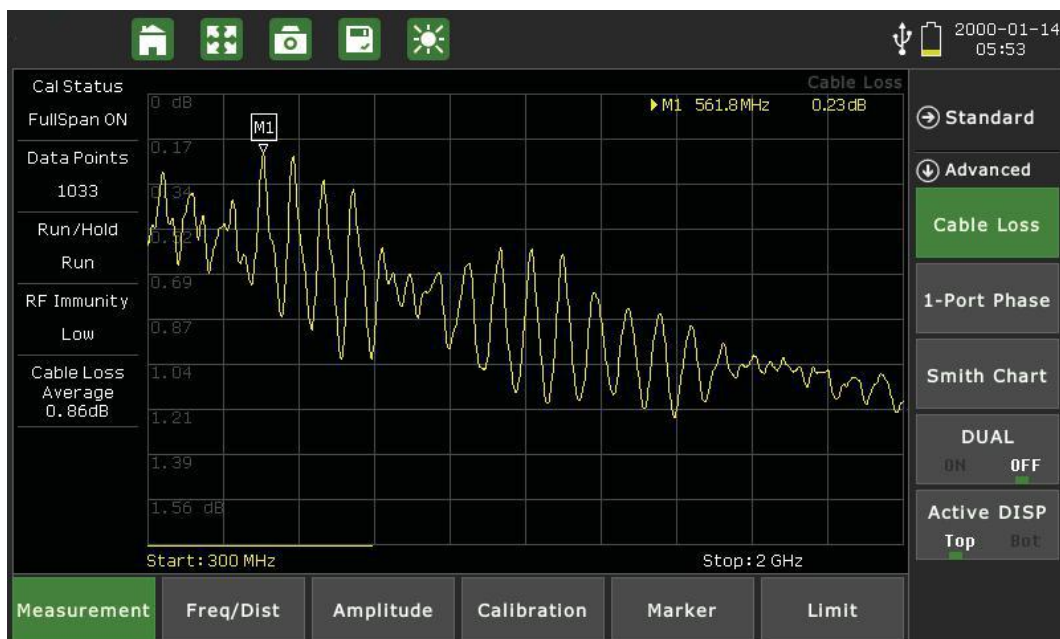

Fig.8.1 Cable loss measurement interface

8.1 Setting Up a One Port Cable Loss Measurement

The following is a step-by-step guide for preparing to conduct a cable loss measurement using the S5700 series's cable analyzer function.

Procedure:

1. To set the instrument in the cable analyzer mode, press the **Menu** button to view the measurement mode desktop. Tap the **Cable & Antenna** softkey.
2. Tap the **Measurement** main menu softkey to open the Measurement menu on the right side of the display. Under the **Advanced** submenu, select **Cable Loss**.
3. Tap the **Freq/Dist** main menu softkey. Under the Frequency submenu, set your desired Start and Stop frequencies. There are two ways to accomplish this.
 - a. Manually enter the desired start frequency by tapping **Start Freq** and using the arrow keys, data keypad,

or rotary knob. Press Enter to confirm. Repeat for **Stop Freq**.

b. Open the **Signal Standard** submenu and tap **Select Signal STD**. Double-tap your preferred signal standard on the list to select it and return to the submenu, then select the signal type by tapping Uplink, Downlink, or Uplink + Downlink.

4. Still under Freq/Dist, open the **Distance** submenu. Enter the start and stop distance; be sure that you toggle **Dist Units** to highlight the correct unit.

5. Still under Freq/Dist, open the **DTF Setup** submenu and tap **Cable**. Double-tap your preferred cable on the list to select it and return to the DTF Setup submenu.

If you are sweeping the entire feedline (jumpers plus main feeder), use the main feedline as the cable type for your measurement.

6. If “ON” appears under Calibration Status on the left-hand side of the display, continue to step 7. Otherwise, you will need to calibrate the instrument. See Chapter 3 — Calibrating the Instrument.

7. Tap the **Amplitude** main menu key, then tap **Auto Scale**. Use the Top and Bottom softkeys, along with the arrow keys, rotary knob, or data keypad, to adjust the amplitude range.

8. Press the **Sweep (#3)** datakey to open the Sweep submenu. Tap Data Points to select the resolution of your measurement. You may choose 130, 259, 517, 1033, or 2056 data points.

The default setting is 259. The higher the setting, the longer it will take to complete a sweep.

9. In the Sweep submenu, tap **RF Immunity** to toggle interference rejection between High and Low depending on your measurement needs.

The default setting is Low. Use High when you suspect a high level of RF signal energy from neighboring cell sites, or other potential interference in the area.

8.2 Making a One Port Cable Loss Measurement

Once you have selected a measurement type and set the desired parameters (as covered in Section 8.1), the instrument is ready to perform the Cable Loss measurement.

Procedure:

1. Connect the antenna or cable feedline to the RF Out port on the instrument, using a test port extension cable if necessary.
2. The measurement trace will appear on the instrument display in real time.
3. You may wish to select Single Sweep, to hold measurement data for easier analysis and saving. For details on analyzing the measurement results, please refer to Chapter 16 — Markers and Limit Lines.

Saving the Measurement:

When you have conducted a successful measurement and wish to save the results for later viewing or analysis, press the **Save** button to the top-right of the display. Cable loss measurements will save as .CBL files. For more details on naming and saving files to the instrument or USB, see Section 34.2.

Chapter 9 One Port Phase Measurement Testing

Introduction

This chapter provides an overview of performing **One-Port Phase** measurements with the S5700 series Signal Analyzer. The **One Port Phase** measurement S11 phase of a reflection measurement, which is commonly used to tune antennas and phase match cables. It is also favored when one end of the cable cannot be brought up to the test instrument – or in cases where “measure-and-snip” operations must be performed to create cables of the right phase length for a prescribed frequency.

The one-port phase measurement is most useful when making relative measurements (comparing the phase of one device to the phase of another) by utilizing the Data Math function. See subsection 4.1.8 for more details on Data Math in the **Trace** menu.)

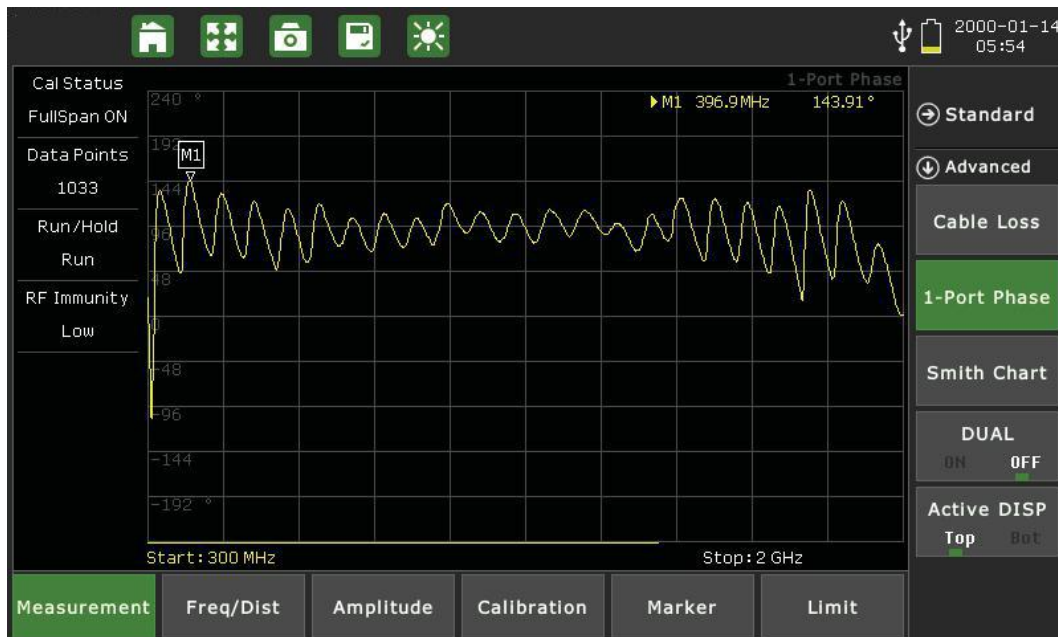

Fig.9.1 One port phase measurement interface

9.1 Setting Up a One Port Phase Measurement

The following is a step-by-step guide for preparing to conduct a one-port phase measurement using the S5700 series’s cable analyzer function.

Procedure:

1. To set the instrument in the cable analyzer mode, press the **Menu** button to view the measurement mode desktop. Tap the **Cable & Antenna** softkey.
2. Tap the **Measurement** main menu softkey to open the Measurement menu on the right side of the display. Under the **Advanced** submenu, select **1-Port Phase**.
3. Tap the **Freq/Dist** main menu softkey. Under the **Frequency** submenu, set your desired Start and Stop frequencies. There are two ways to accomplish this.

- a. Manually enter the desired start frequency by tapping **Start Freq** and using the arrow keys, data keypad, or rotary knob. Press Enter to confirm. Repeat for **Stop Freq**.
- b. Open the **Signal Standard** submenu and tap **Select Signal STD**. Double-tap your preferred signal standard on the list to select it and return to the submenu, then select the signal type by tapping Uplink, Downlink, or Uplink + Downlink.
4. Still under Freq/Dist, open the **Distance** submenu. Enter the start and stop distance; be sure that you toggle **Dist Units** to highlight the correct unit.
5. Still under Freq/Dist, open the **DTF Setup** submenu and tap **Cable**. Double-tap your preferred cable on the list to select it and return to the DTF Setup submenu.

If you are sweeping the entire feedline (jumpers plus main feeder), use the main feedline as the cable type for your measurement.

6. If “ON” appears under Calibration Status on the left-hand side of the display, continue to step 7. Otherwise, you will need to calibrate the instrument. See Chapter 3 — Calibrating the Instrument.

7. Tap the **Amplitude** main menu key, then tap **Auto Scale**. Use the Top and Bottom softkeys, along with the arrow keys, rotary knob, or data keypad, to adjust the amplitude range.

8. Press the **Sweep (#3)** datakey to open the Sweep submenu. Tap Data Points to select the resolution of your measurement. You may choose 130, 259, 517, 1033, or 2056 data points.

The default setting is 259. The higher the setting, the longer it will take to complete a sweep.

9. In the Sweep submenu, tap **RF Immunity** to toggle interference rejection between High and Low depending on your measurement needs.

The default setting is Low. Use High when you suspect a high level of RF signal energy from neighboring cell sites, or other potential interference in the area.

9.2 Making a One Port Phase Measurement

Once you have selected a measurement type and set the desired parameters (as covered in Section 9.1), the instrument is ready to perform the One-port Phase measurement.

Procedure:

1. Connect the antenna or cable feedline to the RF Out port on the instrument, using a test port extension cable if necessary.
2. The measurement trace will appear on the instrument display in real time.
3. You may wish to select Single Sweep, to hold measurement data for easier analysis and saving. For details on analyzing the measurement results, please refer to Chapter 16 — Markers and Limit Lines.

Saving the Measurement:

When you have conducted a successful measurement and wish to save the results for later viewing or analysis, press the **Save** button to the top-right of the display. Phase measurements will save as .PHA files. For more details on naming and saving files to the instrument or USB, see Section 34.2.

Chapter 10 Smith Chart Measurement Testing

Introduction

This chapter provides an overview of performing **Smith Chart** measurements with the S5700 series Signal Analyzer. The Smith Chart is a graphical tool that is used to plot the impedance of the device connected to the RF Out port of the S5700 analyzer. This application converts the measured reflection coefficient data into impedance data, displaying it in a way useful for determining / tuning input match.

This complex impedance plot reveals which matching elements are necessary to match a device under test to the reference impedance. It can also be used to measure the impedance characteristics on filter and duplexer devices, or even to verify the condition of an OSL calibration device that may be damaged.

NOTE: Limit lines and delta markers cannot be set in a Smith Chart measurement.

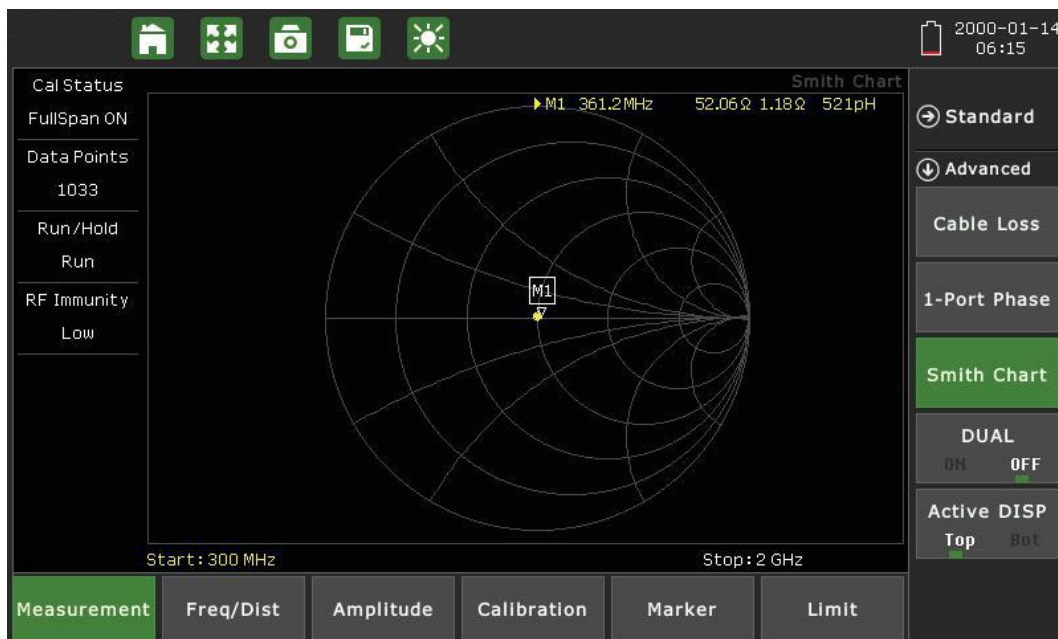

Fig.10.1 Smith chart measurement interface

10.1 Setting Up a Smith Chart Measurement

The following is a step-by-step guide for preparing to conduct a smith chart measurement using the S5700 series's cable analyzer function.

Procedure:

1. To set the instrument in the cable analyzer mode, press the **Menu** button to view the measurement mode desktop. Tap the **Cable & Antenna** softkey.
2. Tap the **Measurement** main menu softkey to open the Measurement menu on the right side of the display. Under the **Advanced** submenu, select **Smith Chart**.
3. Tap the **Freq/Dist** main menu softkey. Under the **Frequency** submenu, set your desired Start and Stop frequencies to cover the normal operating range of the antenna or cable to be measured, plus a suitable margin.

There are two ways to accomplish this.

- a. Manually enter the desired start frequency by tapping **Start Freq** and using the arrow keys, data keypad, or rotary knob. Press Enter to confirm. Repeat for **Stop Freq**.
 - b. Open the **Signal Standard** submenu and tap **Select Signal STD**. Double-tap your preferred signal standard on the list to select it and return to the submenu, then select the signal type by tapping Uplink, Downlink, or Uplink + Downlink.
4. If “ON” appears under Calibration Status on the left-hand side of the display, continue to step 7. Otherwise, you will need to calibrate the instrument. See Chapter 3 — Calibrating the Instrument.
 5. Tap the **Amplitude** main menu key. Use the Scale/DIV softkey to set the scale per division, or tap Full Scale to default to 1 U.
 6. Press the **Sweep (#3)** datakey to open the Sweep submenu. Tap Data Points to select the resolution of your measurement. You may choose 130, 259, 517, 1033, or 2056 data points.

The default setting is 517 The higher the setting, the longer it will take to complete a sweep.

7. In the Sweep submenu, tap **RF Immunity** to toggle interference rejection between High and Low depending on your measurement needs.

The default setting is Low. Use High when you suspect a high level of RF signal energy from neighboring cell sites, or other potential interference in the area.

10.2 Making a Smith Chart Measurement

Once you have selected a measurement type and set the desired parameters (as covered in Section 10.1), the instrument is ready to perform the Smith Chart measurement.

Procedure:

1. Connect the antenna or cable feedline to the RF Out port on the instrument, using a test port extension cable if necessary.
2. The measurement trace will appear on the instrument display in real time.
3. For best results, allow the instrument to perform several sweeps in Continuous mode.

Saving the Measurement:

When you have conducted a successful measurement and wish to save the results for later viewing or analysis, press the **Save** button to the top-right of the display. Smith Chart measurements will save as .SMI files. For more details on naming and saving files to the instrument or USB, see Section 34.2.

Measurement menu:

As in other measurement modes, the user may conduct pass/fail analyses in the Smith Chart application by setting upper and lower limit lines from the Limit (#6) main menu. If the measurement exceeds the specified limit range, the instrument will display a FAIL indicator (and emit an audio signal, if Limit Alarm is on).

However, limit lines function and appear somewhat differently on a Smith Chart. This subsection will provide

step-by-step examples of two ways to set limits in the Smith Chart application.

For a general explanation of using limits with the S5700 SERIES, please see Section 16.2.

Setting a Single Upper Limit Line

1. First, in the Limit menu, toggle Limit Test to **ON**.
2. Tap the **Single Limit** softkey to open a submenu. Here, select **MAX** to set an upper limit.
3. Tap **Single Value** to set the value of the upper limit. A measurement below this value will PASS; one above this value will FAIL. Use the arrow keys, rotary knob, or data keypad to enter 50 Ω , then press Enter to confirm.
4. On the measurement display, passing regions of the measurement will appear in yellow and failing regions will appear in red.

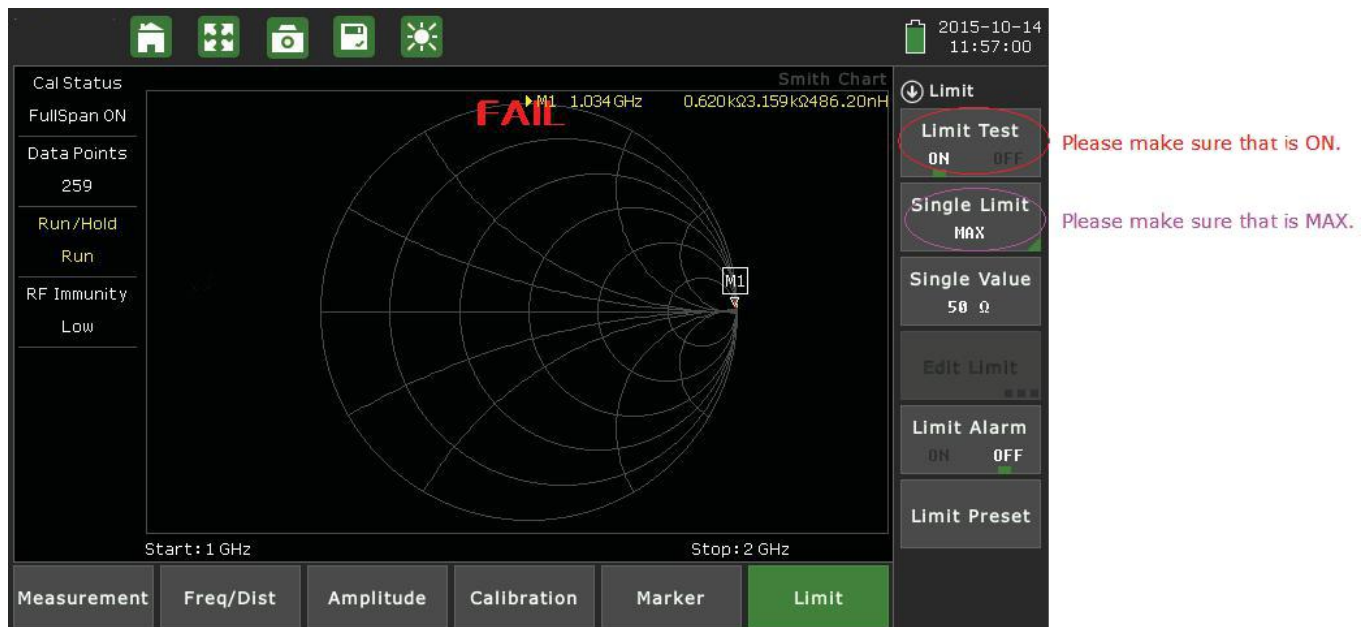

Fig.10.2 Single upper limit line setting interface

Setting a Multi-Segmented Limit Line

1. In the Limit menu, tap Single Limit and select OFF.
2. Tap Edit Limit. The display will shrink to preview the current measurement and display a limit table.
3. Tap Add to add a new limit line to the table. From left to right, you can tap each field to adjust it using the arrow keys, rotary knob, or data keypad. Tap a field once to outline it, and again to edit (or press the Enter button).
4. Create two limit lines according to the table below. (The table displayed on the instrument should match the one provided here.)

#	Type	Begin Frequency	End Frequency	Begin Amplitude	End Amplitude
1	MAX	2 MHz	4.4 GHz	80 Ω	80 Ω
2	MIN	2 MHz	4.4 GHz	20 Ω	20 Ω

5. The measurement preview will change to reflect the new passing limit range: 20 - 80 Ω . Any region of the

measurement trace within this range will appear in yellow. If this reflects the entire trace, the word PASS will appear in green.

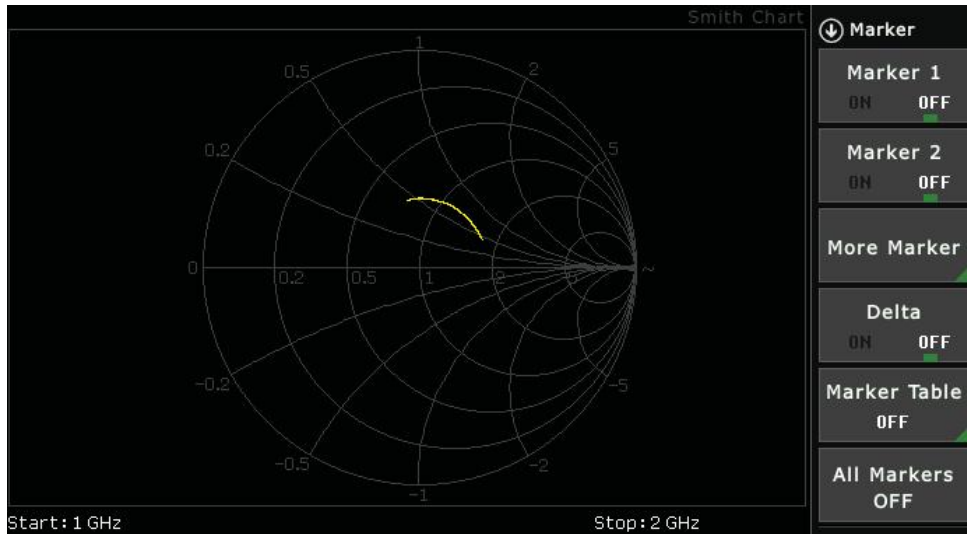

Fig.10.3 Smith chart trace with no limit lines set

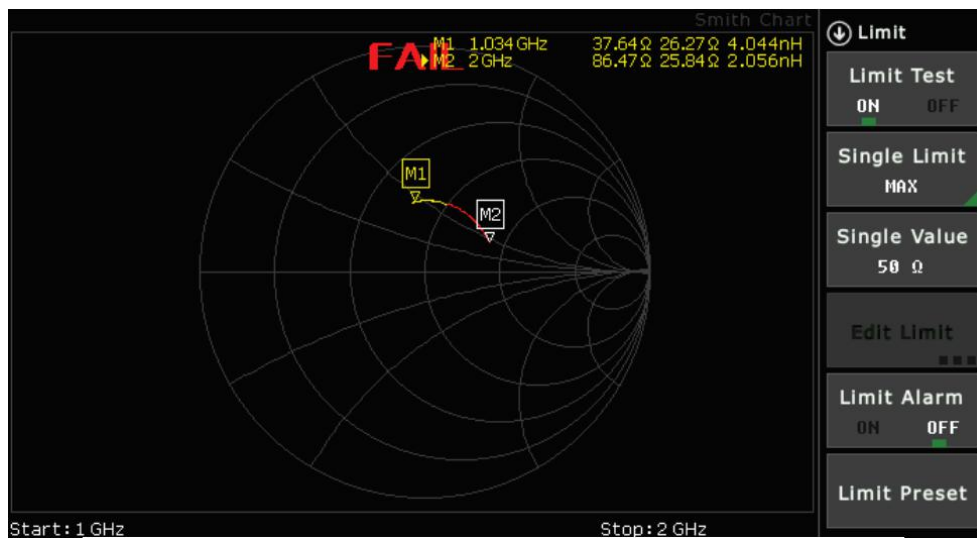

Fig.10.4 Interface that measurement exceeds the limit

Optional Measurement Modes

Aside from Cable & Antenna, additional measurement modes can be added to the S5700 series field comm analyzer's cable analysis functionality - either at the time of purchase, or at a later date as your test needs evolve.

The following chapters provide an overview of these optional measurement modes:

- Inline High Power Meter (Chapter 11)
- Terminal Power Meter (Chapter 12)
- Optical Power Meter (Chapter 13)
- Visual Fault Locator (VFL) (Chapter 14)
- Fiber Inspection (Chapter 15)

You can access software-enabled measurement options by pressing the **Menu** button to the top-right of the display, then selecting from the measurement mode icons.

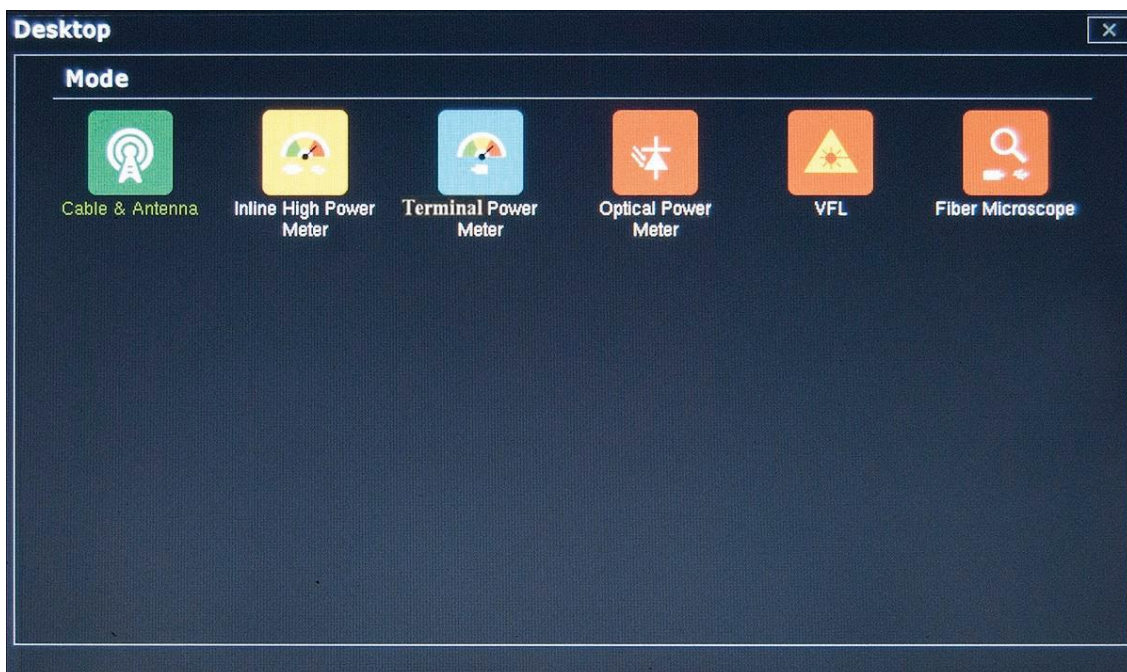

Chapter 11 Inline High Power Meter

Introduction

The **Inline High Power Meter** measurement mode is intended to mimic a traditional thermal (thermo-electric) power sensor. Therefore, it is ideal for measuring the average power of CW or modulated RF waveforms such as 3G, 4G, OFDM, and multi-tone signals. In other words, it measures true RMS power regardless of the type of input signal.

NOTE: Effective use of the Inline High Power Meter mode requires the external power sensor accessory (option S5700-02/03). All instructions in this chapter assume that the power sensor's USB port is connected to the instrument via the USB port on the instrument's top panel.

There are five different measurements within the Inline High Power Meter mode. Refer to the associated section (in parentheses) for details on performing each measurement.

- Average Power, Forward & Reverse (Section 11.1)
- Peak Power (Section 11.2)
- Burst Power & Duty Cycle (Section 11.3)
- Complementary Cumulative Distribution Function (CCDF) (Section 11.4)
- Peak-to-Average (Section 11.5)

Enter this measurement mode by pressing the Menu button to the top-right of the display, then selecting the Inline High Power Meter icon.

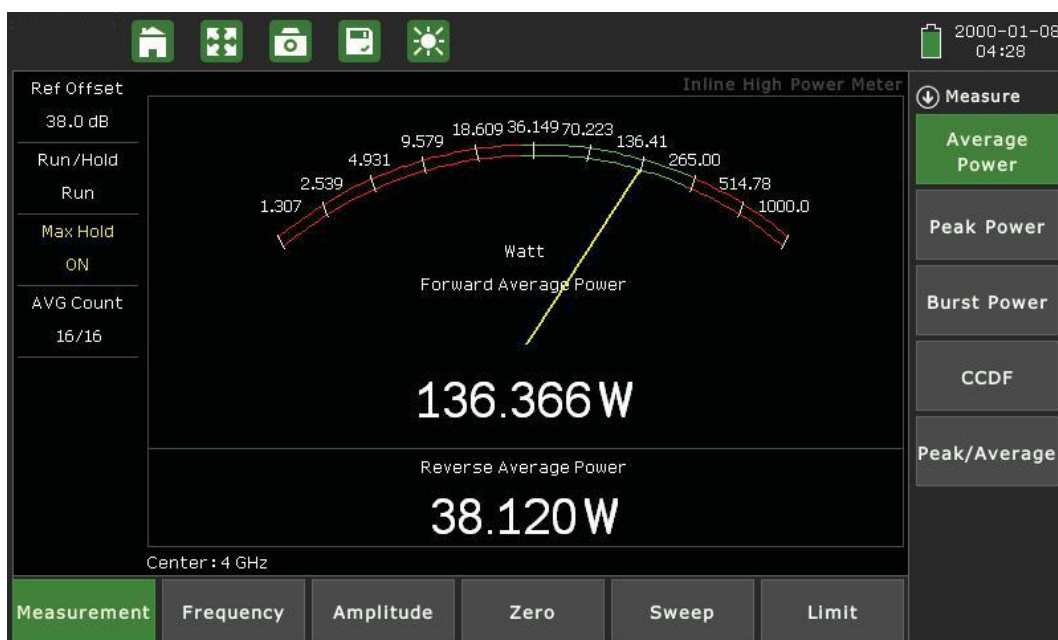

Fig.11.1 Inline high power meter interface

Tips for Power Sensor Use:

Zero the sensor before making power measurements. If frequent low-level measurements are being made, it is advised to check the sensor zeroing often and repeat as necessary. To zero the sensor, open the **Zero** main menu key and tap the **Zero** softkey. (This is not the same as the number “0” on the data keypad.)

The signal channel/analog signal acquisition hardware is integrated along with the RF front end of the power sensor. All of the necessary frequency and temperature corrections take place within the sensor. Therefore, there is no need for a reference calibration with the sensor

11.1 Making an Average Power Measurement

The following is a step-by-step guide for conducting an Average Power measurement in Inline High Power Meter mode. Average power describes the mean power delivered over several cycles. The analog power meter display will depict the forward power reading, or what is being transmitted; the reverse average power depicts the reflected power reading. A high reverse power reading could indicate impedance mismatch issues. Check the channel and transmitter settings.

Procedure:

1. Tap the **Measurement** main menu softkey to open the Measurement menu on the right side of the display. Select **Average Power**.
 2. Tap the **Frequency** main menu softkey. Under the **Frequency** submenu, set your desired center frequency. There are two ways to accomplish this.
 - a. Manually enter the desired start frequency by tapping **Center Freq** and using the arrow keys, data keypad, or rotary knob to adjust. Press Enter to confirm.
 - b. Open the **Signal Standard** submenu and tap **Select Signal STD**. Double-tap your preferred signal standard on the list to select it and return to the submenu, then select the signal type by tapping **Uplink** or **Downlink**. Set a specific channel of interest to test, or enter a **Ch Step** of 1 to test all available channels.
 3. Tap the **Amplitude** main menu key. Use the **Max** and **Min** softkeys, along with the arrow keys, rotary knob, or data keypad, to adjust the amplitude range to display on the on-screen power meter.. You can also tap **Auto Scale** to set the max and min values to where the current measurement is easily visible, or **Full Scale** to display the entire measurement range.
 - a. Adjust **Ref Offset**, if necessary, to compensate for external input attenuation or gain.
 - b. Remember to select the appropriate measurement units.
 4. Tap the **Sweep** main menu key and open the Sweep submenu. Set Sweep Type to **Cont** for continuous measurement, or **Sngl** for a single sweep.
 5. Still in the Sweep main menu, open the **Average** submenu. Toggle Averaging On to activate the per-sweep averaging function, where the measurement displays the mean data of numerous sweeps (as determined by the **AVG Factor**). Use to obtain stable readings from an erratic signal.
 6. If the instrument is properly connected and configured, the yellow needle on the display will swing to indicate the forward average power reading. The reverse average power will appear in a small numerical pane

below.

7. You can toggle **Max Hold** to the left of the display (or in the Sweep menu) to freeze the reading at its highest measured level.

8. The red and green regions on the meter display indicate limit lines. Tap the **Limit** main menu key to adjust your upper and lower limits for pass/fail testing. Enable **Limit Alarm** for an audio failure cue.

Saving the Measurement:

When you have conducted a successful measurement and wish to save the results for later viewing or analysis, press the **Save** button to the top-right of the display. Power Meter measurements will save as .PMM files. For more details on naming and saving files to the instrument or USB, see Section 34.2.

11.2 Making a Peak Power Measurement

The following is a step-by-step guide for conducting a Peak Power measurement in Inline High Power Meter mode.

Procedure:

1. Tap the **Measurement** main menu softkey to open the Measurement menu on the right side of the display. Select **Peak Power**.

2. Tap the **Frequency** main menu softkey. Under the **Frequency** submenu, set your desired center frequency. There are two ways to accomplish this.

a. Manually enter the desired start frequency by tapping **Center Freq** and using the arrow keys, data keypad, or rotary knob to adjust. Press Enter to confirm.

b. Open the **Signal Standard** submenu and tap **Select Signal STD**. Double-tap your preferred signal standard on the list to select it and return to the submenu, then select the signal type by tapping **Uplink** or **Downlink**. Set a specific channel of interest to test, or enter a **Ch Step** of 1 to test all available channels.

3. Tap the **Amplitude** main menu key. Use the **Max** and **Min** softkeys, along with the arrow keys, rotary knob, or data keypad, to adjust the amplitude range to display on the on-screen power meter.. You can also tap **Auto Scale** to set the max and min values to where the current measurement is easily visible, or **Full Scale** to display the entire measurement range.

a. Adjust **Ref Offset**, if necessary, to compensate for external input attenuation or gain.

b. Remember to select the appropriate measurement units.

4. Tap the **Sweep** main menu key and open the Sweep submenu. Set Sweep Type to **Cont** for continuous measurement, or **Sngl** for a single sweep.

5. Still in the Sweep main menu, open the **Average** submenu. Toggle Averaging **On** to activate the per- sweep averaging function, where the measurement displays the mean data of numerous sweeps (as determined by the **AVG Factor**). Use to obtain stable readings from an erratic signal.

6. If the instrument is properly connected and configured, the yellow needle on the display will swing to indicate the forward average power reading. The reverse average power will appear in a small numerical pane

below.

7. You can toggle **Max Hold** to the left of the display (or in the Sweep menu) to freeze the reading at its highest measured level.

8. The red and green regions on the meter display indicate limit lines. Tap the **Limit** main menu key to adjust your upper and lower limits for pass/fail testing. Enable **Limit Alarm** for an audio failure cue.

Saving the Measurement:

When you have conducted a successful measurement and wish to save the results for later viewing or analysis, press the **Save** button to the top-right of the display. Power Meter measurements will save as .PMM files. For more details on naming and saving files to the instrument or USB, see Section 34.2.

11.3 Making a Burst Power Measurement

The following is a step-by-step guide for conducting a Burst Power measurement in Inline High Power Meter mode. This application measures time-gated (non-CW) signal bursts, while the duty cycle describes the percentage of time in a given period during which the signal is on.

Procedure:

1. Tap the **Measurement** main menu softkey to open the Measurement menu on the right side of the display. Select **Burst Power**.

2. Tap the **Frequency** main menu softkey. Under the **Frequency** submenu, set your desired center frequency. There are two ways to accomplish this.

a. Manually enter the desired start frequency by tapping **Center Freq** and using the arrow keys, data keypad, or rotary knob to adjust. Press Enter to confirm.

b. Open the **Signal Standard** submenu and tap **Select Signal STD**. Double-tap your preferred signal standard on the list to select it and return to the submenu, then select the signal type by tapping **Uplink** or **Downlink**. Set a specific channel of interest to test, or enter a **Ch Step** of 1 to test all available channels.

3. Tap the **Amplitude** main menu key. Use the **Max** and **Min** softkeys, along with the arrow keys, rotary knob, or data keypad, to adjust the amplitude range to display on the on-screen power meter. You can also tap **Auto Scale** to set the max and min values to where the current measurement is easily visible, or **Full Scale** to display the entire measurement range.

a. Adjust **Ref Offset**, if necessary, to compensate for external input attenuation or gain.

b. Remember to select the appropriate measurement units.

4. Tap the **Sweep** main menu key and open the Sweep submenu. Set Sweep Type to **Cont** for continuous measurement, or **Sngl** for a single sweep.

5. Still in the Sweep main menu, open the **Average** submenu. Toggle Averaging **On** to activate the per-sweep averaging function, where the measurement displays the mean data of numerous sweeps (as determined by the **AVG Factor**). Use to obtain stable readings from an erratic signal.

6. If the instrument is properly connected and configured, the yellow needle on the display will swing to indicate the forward average power reading. The reverse average power will appear in a small numerical pane below.

7. You can toggle **Max Hold** to the left of the display (or in the Sweep menu) to freeze the reading at its highest measured level.

8. The red and green regions on the meter display indicate limit lines. Tap the **Limit** main menu key to adjust your upper and lower limits for pass/fail testing. Enable **Limit Alarm** for an audio failure cue.

Saving the Measurement:

When you have conducted a successful measurement and wish to save the results for later viewing or analysis, press the **Save** button to the top-right of the display. Power Meter measurements will save as .PMM files. For more details on naming and saving files to the instrument or USB, see Section 34.2.

11.4 Making a CCDF Measurement

The following is a step-by-step guide for conducting a Complementary Cumulative Distribution Function (CCDF) measurement in Inline High Power Meter mode. The CCDF measurement provides the percentage of time the signal spends at or above a specific power level (with the power level expressed in units of dB, relative to the average power level).

Procedure:

1. Tap the **Measurement** main menu softkey to open the Measurement menu on the right side of the display. Select **CCDF**.

2. Tap the **Frequency** main menu softkey. Under the **Frequency** submenu, set your desired center frequency. There are two ways to accomplish this.

a. Manually enter the desired start frequency by tapping **Center Freq** and using the arrow keys, data keypad, or rotary knob to adjust. Press Enter to confirm.

b. Open the **Signal Standard** submenu and tap **Select Signal STD**. Double-tap your preferred signal standard on the list to select it and return to the submenu, then select the signal type by tapping **Uplink** or **Downlink**. Set a specific channel of interest to test, or enter a **Ch Step** of 1 to test all available channels.

3. Tap the **Amplitude** main menu key. Use the **Max** and **Min** softkeys, along with the arrow keys, rotary knob, or data keypad, to adjust the amplitude range to display on the on-screen power meter.. You can also tap **Auto Scale** to set the max and min values to where the current measurement is easily visible, or **Full Scale** to display the entire measurement range.

a. Adjust **Ref Offset**, if necessary, to compensate for external input attenuation or gain.

b. Remember to select the appropriate measurement units.

4. Tap the **Sweep** main menu key and open the Sweep submenu. Set Sweep Type to **Cont** for continuous measurement, or **Sngl** for a single sweep.

5. Still in the Sweep main menu, open the **Average** submenu. Toggle Averaging **On** to activate the per-sweep averaging function, where the measurement displays the mean data of numerous sweeps (as determined by the **AVG Factor**). Use to obtain stable readings from an erratic signal.

6. If the instrument is properly connected and configured, the CCDF reading will appear on the instrument display.

7. You can toggle **Max Hold** to the left of the display (or in the Sweep menu) to freeze the reading at its highest measured level.

Saving the Measurement:

When you have conducted a successful measurement and wish to save the results for later viewing or analysis, press the **Save** button to the top-right of the display. Power Meter measurements will save as .PMM files. For more details on naming and saving files to the instrument or USB, see Section 34.2.

11.5 Making a Peak-to-Average Measurement

The following is a step-by-step guide for conducting a Peak/Average measurement in Inline High Power Meter mode. This displays the ratio of the peak measured power level to the time-averaged power level. This is also known as the PAR or crest factor.

Procedure:

1. Tap the **Measurement** main menu softkey to open the Measurement menu on the right side of the display. Select **Peak/Average**.

2. Tap the **Frequency** main menu softkey. Under the **Frequency** submenu, set your desired center frequency. There are two ways to accomplish this.

a. Manually enter the desired start frequency by tapping **Center Freq** and using the arrow keys, data keypad, or rotary knob to adjust. Press Enter to confirm.

b. Open the **Signal Standard** submenu and tap **Select Signal STD**. Double-tap your preferred signal standard on the list to select it and return to the submenu, then select the signal type by tapping **Uplink** or **Downlink**. Set a specific channel of interest to test, or enter a **Ch Step** of 1 to test all available channels.

3. Tap the **Amplitude** main menu key. Use the **Max** and **Min** softkeys, along with the arrow keys, rotary knob, or data keypad, to adjust the amplitude range to display on the on-screen power meter. You can also tap **Auto Scale** to set the max and min values to where the current measurement is easily visible, or **Full Scale** to display the entire measurement range.

a. Adjust **Ref Offset**, if necessary, to compensate for external input attenuation or gain.

b. Remember to select the appropriate measurement units.

4. Tap the **Sweep** main menu key and open the Sweep submenu. Set Sweep Type to **Cont** for continuous measurement, or **Sngl** for a single sweep.

5. Still in the Sweep main menu, open the **Average** submenu. Toggle Averaging **On** to activate the per-sweep

averaging function, where the measurement displays the mean data of numerous sweeps (as determined by the **AVG Factor**). Use to obtain stable readings from an erratic signal.

6. If the instrument is properly connected and configured, the peak-to-average reading will appear on the instrument display.

Saving the Measurement:

When you have conducted a successful measurement and wish to save the results for later viewing or analysis, press the **Save** button to the top-right of the display. Power Meter measurements will save as .PMM files. For more details on naming and saving files to the instrument or USB, see Section 34.2.

Chapter 12 Terminal Power Meter

Introduction

The **Terminal Power Meter** measurement mode provides standard-accuracy RF power testing without the need for external equipment. Simply connect the source to be measured to the n(m) power meter connector on the instrument's top panel.

NOTE: The power meter port is rated for connections up to, but not exceeding, +27 dBm / $\pm 50V$ DC.

Enter this measurement mode by pressing the **Menu** button to the top-right of the display, then selecting the Terminal Power Meter icon.



Fig. 12.1 Terminal power meter interface

The following is a step-by-step guide for conducting a power level measurement in the Terminal Power Meter mode.

Procedure:

1. Tap the **Frequency** main menu softkey. Under the **Frequency** submenu, set your desired center frequency. There are two ways to accomplish this.
 - a. Manually enter the desired start frequency by tapping **Center Freq** and using the arrow keys, data keypad, or rotary knob to adjust. Press Enter to confirm.
 - b. Open the **Signal Standard** submenu and tap **Select Signal STD**. Double-tap your preferred signal standard on the list to select it and return to the submenu, then select the signal type by tapping **Uplink** or **Downlink**. Set a specific channel of interest to test, or enter a **Ch Step** of 1 to test all available channels.
2. Tap the **Amplitude** main menu key. Use the **Max** and **Min** softkeys, along with the arrow keys, rotary knob, or data keypad, to adjust the amplitude range of interest. You can also tap **Auto Scale** to set the max and min

values to where the current measurement is easily visible, or **Full Scale** to display the entire measurement range.

- a. Adjust **Ref Offset**, if necessary, to compensate for external input attenuation or gain.
- b. Remember to select the appropriate measurement units.
3. Tap the **Sweep** main menu key. Set Sweep Type to **Cont** for continuous measurement, or **Sngl** for a single sweep.
4. Still in the Sweep main menu, open the **Average** submenu. Toggle Averaging On to activate the per-sweep averaging function, where the measurement displays the mean data of numerous sweeps (as determined by the **AVG Factor**). Use to obtain stable readings from an erratic signal.
5. If the instrument is properly connected and configured, the power reading will appear in real-time on the instrument display.
6. You can toggle **Max Hold** to the left of the display (or in the Sweep menu) to freeze the reading at its highest measured level.
7. The red and green regions on the meter display indicate limit lines. Tap the **Limit** main menu key to adjust your upper and lower limits for pass/fail testing. Enable **Limit Alarm** for an audio failure cue.

Saving the Measurement:

When you have conducted a successful measurement and wish to save the results for later viewing or analysis, press the **Save** button to the top-right of the display. Power Meter measurements will save as .PMM files. For more details on naming and saving files to the instrument or USB, see Section 34.2.

Chapter 13 Optical Power Meter

Introduction

The **Optical Power Meter** function of the S5700 series enables power measurements without carrying a separate power meter accessory or additional tools. This mode displays the power level on an analog meter in real time. Simply connect the fiber line to the OPM port on the instrument's top panel, between the RF Out and VFL ports. Configurable settings include display range, upper and lower limits, and power units (dBm or watts).

Enter this measurement mode by pressing the **Menu** button to the top-right of the display, then selecting the **Optical Power Meter** icon.



Fig.13.1 Optical power meter interface

The following is a step-by-step guide for conducting a power level measurement in the Optical Power Meter mode.

Procedure:

1. Tap the **Wavelength** main menu softkey. Select one of the listed wavelengths (in nm): 850, 980, 1300, 1310, 1490, 1550, 1610. Your selection will appear in the bottom-left-hand corner of the measurement display.
2. Tap the **Amplitude** main menu key. Use the **Max** and **Min** softkeys, along with the arrow keys, rotary knob, or data keypad, to adjust the amplitude range to display on the on-screen power meter. You can also tap **Auto Scale** to set the max and min values to where the current measurement is easily visible, or **Full Scale** to display the entire measurement range.
 - a. Adjust **Ref Offset**, if necessary, to compensate for external input attenuation or gain.
 - b. Remember to select the appropriate measurement units: **dBm** or **Watts**.
3. Tap the **Sweep** main menu key. Set Sweep Type to **Cont** for continuous measurement, or **Sngl** for a single sweep.
4. Still in the Sweep main menu, open the **Average** submenu. Toggle Averaging On to activate the per-sweep

averaging function, where the measurement displays the mean data of numerous sweeps (as determined by the **AVG Factor**). Use to obtain stable readings from an erratic signal.

5. If the instrument is properly connected and configured, the yellow needle on the display will swing to indicate the power reading in real time.

6. You can toggle **Max Hold** to the left of the display (or in the Sweep menu) to freeze the reading at its highest measured level.

7. The red and green regions on the meter display indicate limit lines. Tap the **Limit** main menu key to adjust your upper and lower limits for pass/fail testing. Enable **Limit Alarm** for an audio failure cue.

Saving the Measurement:

When you have conducted a successful measurement and wish to save the results for later viewing or analysis, press the **Save** button to the top-right of the display. Power Meter measurements will save as .PMM files. For more details on naming and saving files to the instrument or USB, see Section 34.2.

Chapter 14 Visual Fault Locator (VFL)

Introduction

The **Visual Fault Locator** function of the S5700 series enables visual confirmation of equipment faults without having to carry a separate piece of test equipment. This function provides a tightly-focused beam of red light, enabling you to check for damaged, broken, or spliced optical fibers and high-loss connectors (particularly important in short fiber lengths, where an OTDR cannot detect the fault). VFL can also trace the patch of fiber through multiple connections and identify the correct two fibers for loss testing.

NOTE: The beam emitted by the VFL can cause vision damage. For your safety, do not look directly at the light beam for extended periods of time.

Enter this measurement mode by pressing the **Menu** button to the top-right of the display, then selecting the **VFL** icon.

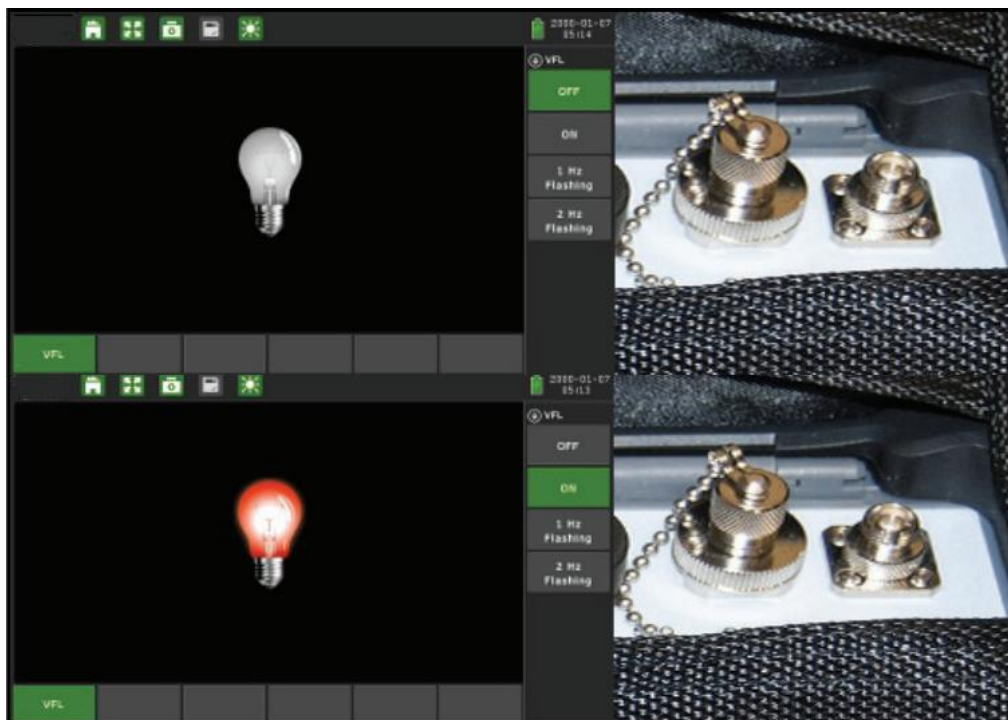



Fig.14.1 VFL measurement interface

The following is a step-by-step guide to using the VFL option.

Procedure:

1. On the top panel, locate the VFL emitter port marked with the following symbol. 
2. Unscrew the chained metal cap covering the port and leave it aside. Be careful not to look directly into this port while using the instrument.
3. To set the instrument in the VFL mode, press the **Menu** button to view the measurement mode desktop. Tap the **VFL** softkey.
4. The VFL main menu will automatically appear to the right side of the display.

-
- a. Tap **OFF** to disable the light. The displayed lightbulb icon will turn white.
 - b. Tap **ON** to activate the light, which will shine continuously. The lightbulb icon will turn red.
 - c. Tap **1 Hz Flashing** to automatically switch the light on and off at about 1 flash per second.
 - d. Tap **2 Hz Flashing** to automatically switch the light on and off at about 2 flashes per second.
5. Connect the fiber to the port. Light will leak through the sheath, highlighting cracks and bends.

Chapter 15 Fiber Inspection

Introduction

The **Inspection** of fiber optic connections is essential to ensure the performance and longevity of fiber-optic connectivity. Throughout their lives, fiber connectors must be inspected, analyzed, and cleaned to maintain an acceptable level of functionality. The S5700 series makes it fast and easy to troubleshoot and certify that every connection at a cell site is optimized for enduring performance.

The instrument supports a handheld fiber probe accessory, which is used to capture video images from the sensor, analyze the images for fiber-end face defects and contamination, and provide reliable PASS/FAIL results to guarantee the performance of your optical connections.

NOTE: Effective use of the Fiber Inspection mode requires the external fiber probe. All instructions in this chapter assume that the probe is connected to the instrument via the USB port on the instrument's top panel.

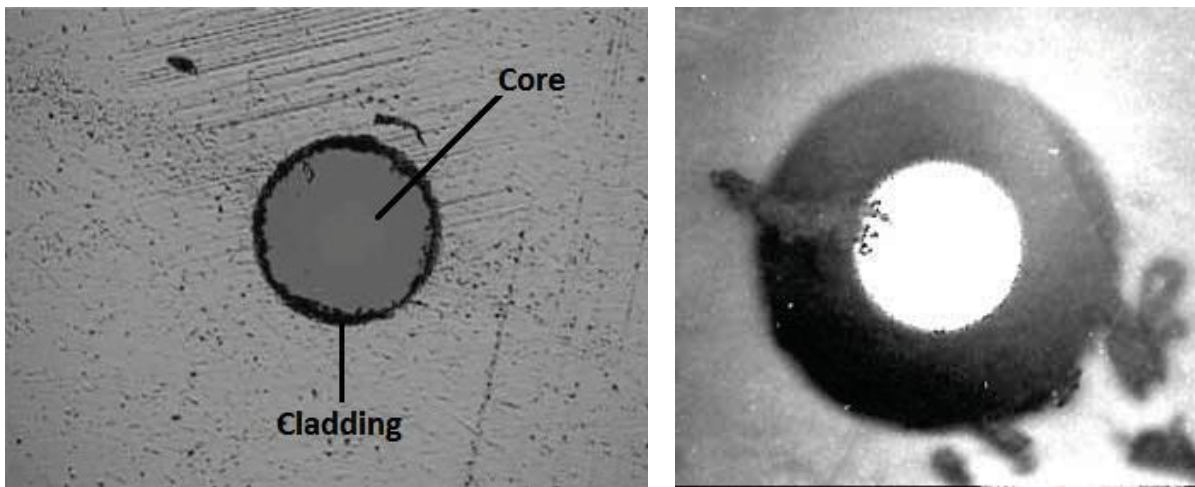

Fig.15.1 Examples of fiber inspection: showing structure of line (left); contaminated by dirt (right)

The following is a step-by-step guide to inspecting optical fiber health with S5700 series's cable analyzer function and the fiber probe.

Procedure:

1. To set the instrument in the Fiber Inspection mode, press the Menu button to view the measurement mode desktop. Tap the Fiber Microscope softkey.
2. Connect the fiber to be inspected to the tip of your microscope. The live video feed will appear on the instrument's measurement display.
3. Tap the Display main menu key. Tap Brightness and use arrow keys, rotary knob, or data keypad to adjust the brightness of the image. Press Enter to confirm. Repeat for Contrast and Sharpness.
4. As you inspect the fiber quality, you can toggle Run/Hold on the left side of the display (or under the Measurement main menu) to freeze the current image. Press the Save button to save the image to internal memory as a .BMP or .FMI file.
5. For more on saving measurement data/images, see Section 34.2.

Chapter 16 Markers and Limit Lines

Introduction

When you have successfully completed a measurement and wish to analyze the results, several options are open to you. Activating markers or marker functions will provide you with a readout of the RF measurement at a specific point, giving you the amplitude reading at a given frequency. Setting limit lines enables a quick “pass/fail” analysis of the reflection performance.

16.1 Setting a Marker

A marker is a tool for extracting results from traces (or from trace memory). Among other functions, markers can be used to measure the amplitude of a spike on a cable analyzer measurement, or to indicate certain places on the sweep. Using markers and delta markers, you can make many measurements that deal with the change in power with frequency or time.

To set one or more independent markers on the measurement display, tap the Marker main menu softkey. Ensure that the Marker submenu is open and follow the steps below.

In the menu on the right-hand side of the screen, you can toggle Marker 1 and Marker ON/Off. Whichever marker you last selected will be the **active marker**, indicated by a small green square (■) next to its name in the Marker menu. The active marker can be freely moved along the measurement trace with the arrow keys or rotary knob. You may also use the data keypad to enter a numerical position in distance units; enter the value, then tap the desired unit (km, m, cm, or mm) in the submenu that appears to the right.

NOTE: Although multiple markers (up to eight) can be turned on, only one can be the current active marker (meaning that this marker can be moved, the mode changed, etc). All other markers, although on, are frozen in the spot they were placed at the time they were activated.

Tap **Marker Table** to toggle it On/Off; this setting displays a list of currently placed markers and their positions underneath the measurement display. Select Large Display to show only the active marker's location in larger type.

Tap **All Markers OFF** to disable all placed markers. Markers turned off and back on will retain their position. Open the More Markers submenu to set additional markers. You can set up to eight markers at a time.

Selecting, Activating and Placing a Delta Marker

When the Delta marker is set, the position set by the Delta marker becomes the reference position of the corresponding Normal marker, and the marker's X and Y values display the difference compared with the Delta marker. The reference position will be fixed.

1. In the **Marker** submenu, toggle the marker of your choice **On** (making it the active marker).
2. Toggle the **Delta** function **On** to activate the delta marker corresponding to the active normal marker. Delta markers are indicated by a Δ icon (e.g., Marker 1's delta is $\Delta 1$). In the top-right of the display, the difference between delta markers' and their corresponding normal markers' positions will appear.
3. To add additional delta markers, repeat steps 1 and 2.

Using Marker Auto Search

In the Marker main menu, tap **Search** to open the Search submenu. These functions can be used to automatically guide the active marker to the highest or lowest point of the measurement (**Marker to MAX/MIN**), to particular peaks and valleys (**Marker to Peak/Valley**), or to fault points (**Auto Search Fault Point**).

16.2 Using Limit Lines

Limit lines can be used for setting pass/fail criteria, or simply for the user's visual reference. Limit failures are reported whenever a signal is above the upper limit line or below the lower limit line. Two types of limit lines can be specified: lower limit lines and upper limit lines.

A limit line may consist of a single segment or as many as 40 segments. These limit segments are retained regardless of the current frequency span of the instrument, which allows the configuring of specific limit envelopes at various frequencies of interest - without having to re-configure them each time the frequency is changed.

An upper (MAX) limit will automatically mark red any regions of the measurement that are higher than specified, and will display a FAIL sign. A lower (MIN) limit will do the same for any regions lower than specified. To set one or more limit lines on the measurement display, press the **Limit (#6)** datakey or tap the Limit menu key along the bottom of the display.

Limit function may differ depending on the active measurement mode. For instance, power meter limit lines appear as borders of a green zone on the meter, indicating the region of "pass" (within-limit) values. The following instructions apply chiefly to limit function within the Cable Analyzer measurement mode.

Setting a Single Limit Line

1. First, in the Limit menu, toggle **Limit Test** to ON to display the limit line in red.
2. Tap the **Single Limit** softkey to open a submenu. Here you can select **MAX** to set an upper limit, **MIN** to set a lower limit, or **OFF** to cancel and return.
3. Tap **Single Value** to set the limit line's position. Use the arrow keys, rotary knob, or data keypad to adjust, then press Enter to confirm.

Setting Multiple Limit Line

1. In the Limit menu, tap **Single Limit** and select **OFF**.
2. Tap **Edit Limit**. The display will shrink to accommodate a preview of the current measurement and a limit table.
3. Tap **Add** to add a new limit line to the table. From left to right, you can tap each field to adjust it using the arrow keys, rotary knob, or data keypad. Tap a field once to outline it, and again to edit.
 - a. **Type:** Choose OFF to turn off the limit, MIN to set an upper limit, or MAX to set a lower limit.
 - b. **Begin Distance:** Set the distance at which the limit will begin testing for pass/fail. Enter a value, then select the intended distance unit: km, m, cm, or mm.
 - c. **End Distance:** Set the distance at which the limit will stop testing for pass/fail.
 - d. **Begin Amplitude:** Set the amplitude (how high/low) for the start of the limit line. You can use this feature

to set a limit that rises or falls at various points through the measurement.

- e. **End Amplitude:** Set the amplitude (how high/low) for the end of the limit line.
4. Tap anywhere on an unwanted limit line in the table and tap **Delete** to erase it.
5. You may set up to 20 limit lines. When you are finished, tap **Return** to go back.

Limit Alarm

If active, the Limit Alarm feature notifies the user with a series of audible beeps if the current measurement exceeds a placed limit line. Simply tap the Limit Alarm softkey to toggle it ON or OFF.

Part 2

Spectrum Analyzer

Chapter 17 Spectrum Analyzer Menus

This chapter contains maps and descriptions of the S5700 series analyzer's spectrum analyzer menus. Main menus are located along the bottom edge of the display and can be tapped to enter their respective submenus. Submenus are located along the right edge of the display, and are listed in the order they appear.

Main menus are indicated with **bold text**. Submenus are indicated with an arrow. ">" indicates a closed (sub)menu. "V" indicates an open (sub)menu, with its contents (with default values) listed below.

Measurement modes not addressed in this chapter will be covered in a separate measurement guide.

Spectrum Analyzer Mode Menus

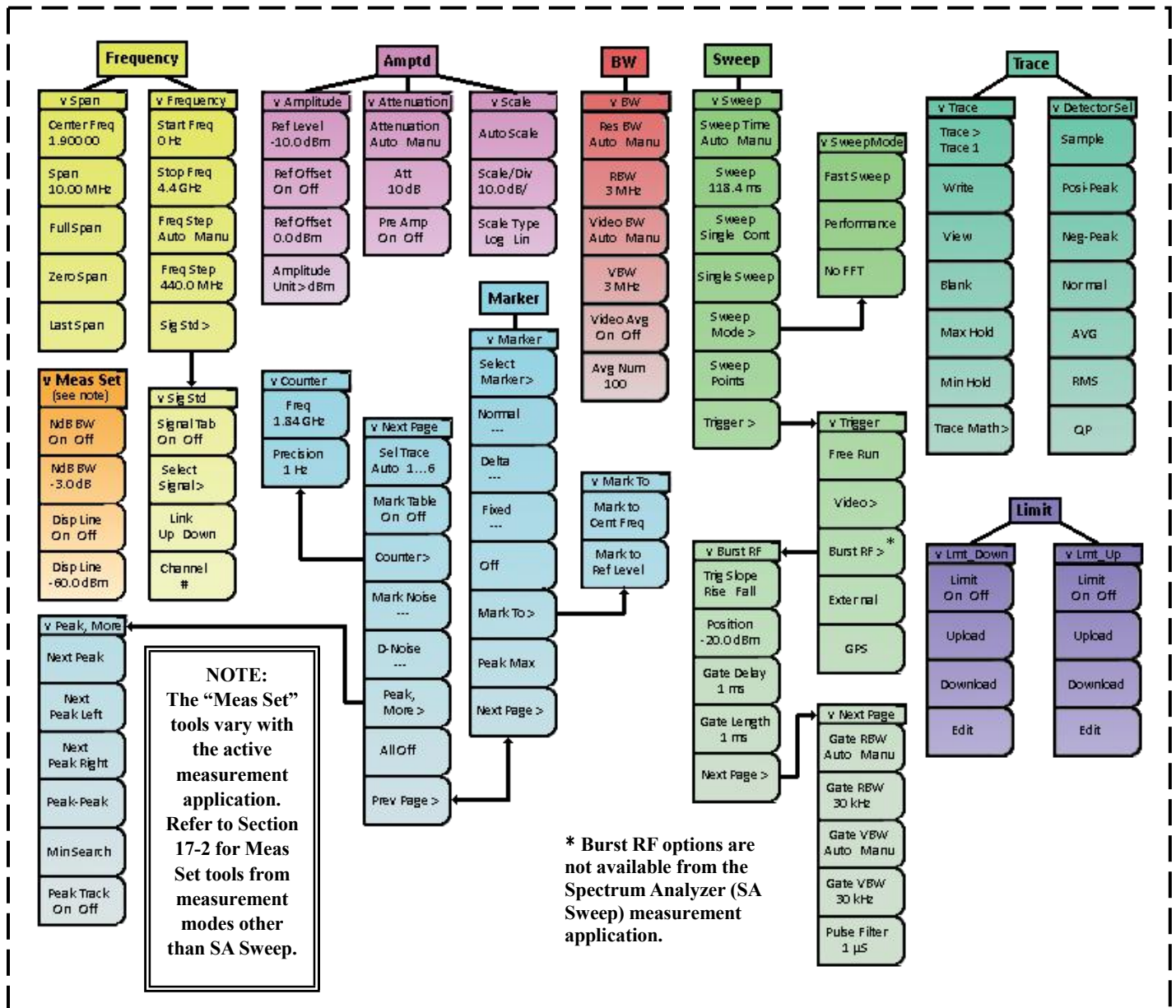

17.1 Spectrum Analyzer Menus & Definitions

This section defines the various spectrum analyzer menus and functions. Subsections 17.1.1 through 17.1.8 highlight the main menu items of the spectrum analyzer (Frequency, Amplitude, Bandwidth, Sweep, Markers, Measurement Setup, Trace, and Limit), along with their corresponding submenus.

For information on One-Button Measurement menus, please see Section 17.2.

17.1.1 Frequency menu

Entering the frequency range on the S5700A/B can be accomplished in several different ways, depending on what makes the most sense for the user or the application. The center frequency and span can be specified, or start and stop frequencies can be entered, or a signal standard and channel number can be selected from the built-in signal list.

	<p>Center Freq: With the Span submenu open, tap the Center Freq submenu softkey to enter the desired center frequency using the data keypad. When entering a frequency using the data keypad, the submenu changes to GHz, MHz, kHz and Hz. Select a unit to proceed.</p> <p>Span: The Span submenu softkey shows the current span setting. To adjust it, tap the key and enter the desired span using the data keypad. The submenu will change to GHz, MHz, kHz and Hz. Select a unit to proceed.</p> <p>Full Span: Tapping the Full Span submenu softkey sets the span to cover the entire operating frequency range of the unit.</p> <p>Zero Span: Tapping the Zero Span submenu softkey sets the unit to zero span. In this mode the display shows amplitude changes at a single frequency. This function is frequently used to allow the easy monitoring of power variations over time, or to tune in to a single specific frequency.</p> <p>Last Span: This submenu softkey returns the span to the most recent span value immediately before a change was made.</p>
--	--

	<p>Start Freq: Tap to set the start frequency. Enter the desired start frequency with the data keypad; and the submenu will change to GHz, MHz, kHz and Hz. Select a unit to proceed.</p> <p>Stop Freq: Tap to set the stop frequency. Enter the desired stop frequency with the data keypad; and the submenu will change to GHz, MHz, kHz and Hz. Select a unit to proceed.</p> <p>Freq Step: Tapping the Freq Step submenu softkey toggles the frequency step mode from Auto to Manual, and vice-versa. The default setting is "Auto".</p> <p>Freq Step: Tap to set the frequency step size: the amount by which a frequency will change when the up or down arrow keys are pressed. The frequency range will change according to the step size. Enter the desired step size using the data keypad and the submenu will change to GHz, MHz, kHz and Hz. Select a unit to proceed.</p> <p>Sig Std: Tapping the Sig Std submenu softkey opens the Signal Standard submenu, where users may toggle the Signal Tab and select a specific signal standard from the Select Signal list, as well as the specific channel number and respective downlink or uplink.</p>
---	--

17.1.2 Amplitude menu (Amptd)

	<p>Ref Level: The reference level refers to the top grid line on the units measurement display, and can be set from -5 dBm to -167 dBm. Use the arrow keys, rotary knob, or data keypad to input a value. If prompted, tap to select a unit (Hz, kHz, MHz or GHz).</p>
	<p>Ref Offset: Tapping this key toggles the Ref Offset ON or OFF. The default setting is OFF.</p>
	<p>Ref Offset: The Ref Offset, when ON, compensates for the presence of external input attenuation or gain. Use the arrow keys, rotary knob, or data keypad to input a value. Press Enter to confirm</p>
	<p>Amplitude Units: Tapping this key opens a list of amplitude units (to dBm, dBmV, dBμV, Volt and Watt). Tap the desired unit to change your selection.</p>

	<p>Attenuation: Tapping this key toggles the Attenuation from Auto to Manual (Manu) and vice-versa. The default setting is Auto.</p>
	<p>Attenuation Level: Tapping the Att key allows you to manually adjust the attenuation level. Use the data keypad, the arrow keys, or the rotary knob to enter the desired value.</p>
	<p>Pre Amp: Tapping this key toggles the preamplifier ON or OFF. Notice that when the preamplifier is turned on, the noise floor drops significantly.</p>

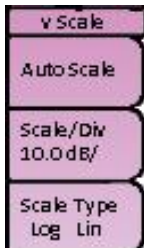
	<p>Auto Scale: Tapping this key auto-configures the scale. To adjust it manually, use Scale/Div.</p>
	<p>Scale/Div: Tapping this key allows you to manually adjust the scale. Use the data keypad, the arrow keys, or the rotary knob to enter the desired value.</p>
	<p>Scale Type: Tapping this key toggles the scale calculation between logarithmic and linear.</p>

17.1.3 Bandwidth menu (BW)

	<p>Res BW: Tapping this key toggles the RBW mode between Auto and Manual. On Auto, the instrument automatically sets the resolution bandwidth based on current span setting.</p>
	<p>RBW: The current resolution bandwidth value is displayed in this submenu software key. To change the RBW to a specific setting, tap the Res BW submenu softkey to manual mode (Manu), then tap the RBW submenu softkey and use the up/down arrow key to change the RBW setting. The RBW range is 1 Hz to 3 MHz in a 1-3 sequence.</p>
	<p>Video BW: Tapping this key toggles the VBW mode between Auto and Manual. On Auto, the instrument automatically sets the video bandwidth based on current RBW setting.</p>
	<p>VBW: The current video bandwidth value is displayed in this submenu software key. To change the VBW to a specific setting, tap the Video BW submenu softkey to manual mode (Manu), then tap the VBW submenu softkey and use the up/down arrow key to change the VBW setting. The VBW range is 1 Hz to 3 MHz in a 1-3 sequence.</p>
	<p>Video Average: Tapping this key toggles the Video Avg mode between Auto and Manual.</p>
	<p>Avg Num: The Avg Num submenu softkey displays the current number of video averages.</p>

17.1.4 Sweep menu (Sweep)

	<p>Sweep Time: Tapping this key toggles the Sweep mode from Auto to Manual (Manu) and vice-versa. Auto Sweep (default setting) causes the instrument to automatically select the resolution bandwidth based on the current span setting.</p>
	<p>Sweep: The current sweep speed value is displayed in this submenu software key. To change the sweep speed to a specific setting, tap the Sweep Time submenu softkey to manual mode (Manu), then tap the Sweep submenu softkey and use the up/down arrow key to change the sweep time. You can also enter the desired sweep time using the data keypad to the right of the display. When entering a sweep time using the data keypad, the submenu changes to sec, msec and μsec. Press the appropriate unit key to enter your selection.</p>
	<p>Sweep: Tapping this key toggles the Sweep mode from Single to Continuous sweep and vice-versa. Continuous sweep is the default mode.</p>
	<p>Single Sweep: When Sweep is set to Single, tapping Single Sweep triggers a single measurement sweep. This key has no function in continuous sweep mode.</p>
	<p>Sweep Mode >: Tapping this key opens the Sweep Mode submenu.</p>
	<p>Sweep Points: The current number of sweep points is displayed in this submenu software key. The default setting is 517 points. Maximum number of data points is 10,000.</p>
	<p>Trigger >: Opens the Trigger submenu, providing a choice of Free Run and Video.</p>

	<p>Sweep Time: Tapping this submenu softkey selects Fast Sweep (FFT mode) as the desired sweep mode. This sweep speed mode provides the fastest sweep speed and is ideal for capturing fast, intermittent signals, including various forms of signal interference.</p>
	<p>Performance: Tapping this submenu softkey selects Performance as the desired sweep mode. This sweep speed mode provides the best amplitude accuracy and ensures that all specifications are met.</p>
	<p>No FFT: Tapping this submenu softkey selects No FFT as the desired sweep mode. This is the slowest sweep speed. It is commonly used for analog and pulse-modulated signals.</p>

	<p>Free Run: In this mode, a new sweep is started immediately upon completion of the previous sweep. No trigger event is required to imitate a sweep. This is the default setting.</p>
	<p>Video: This softkey opens the Video submenu. In this submenu, you can adjust the Position (trigger level to initiate a measurement, used when External triggering is active) and set the trigger slope to rising or falling.</p>
	<p>Burst RF >: Opens the Burst RF submenu. This submenu is not available in all measurement modes, and Burst RF must be toggled ON to access it. See subsection 17-2.2 for additional information on Burst RF functions and parameters.</p>
	<p>External: This mode is used in zero span. A TTL signal applied to the External reference input connector causes a single sweep to occur. Triggering occurs on the rising edge of the signal. After the sweep, the resultant trace is displayed until the next trigger signal arrives.</p>
	<p>GPS >: Opens the GPS submenu, where users can manage the instrument's built-in GPS functionality. You can enable GPS in System Setup; see subsection 35.1.5.</p>

17.1.5 Marker menu (Marker)

v Marker	Select Marker >: Tapping this key opens the marker selection submenu. Tap to select which marker (1, 2, 3, 4, 5, or 6) you want active. The active marker will be displayed on the Select Marker submenu softkey.
Select Marker >	Normal: Tapping this key activates the normal marker function. Normal is the most common marker mode for general use.
Normal ---	Delta: Tapping this key sets a delta marker based on the frequency and amplitude on the current active normal marker.
Delta ---	Fixed: Tapping this key activates the fixed marker function.
Fixed ---	Off: Tapping this key turns OFF the current active marker. (To turn off multiple markers at the same time, tap Next Page and select ALL OFF).
Off	Marker To > : Opens a submenu of Marker To options. Choices include Mark to Center Freq and Mark to Ref Level.
Mark To >	Peak Max: This places the active marker on the highest signal amplitude currently displayed on the screen.
Peak Max	Next Page: Opens a submenu of additional marker options; see following table.
Next Page >	

v Next Page	Sel Trace >: Opens the trace selection submenu. Users can set up to six individual traces.
Sel Trace Auto 1...6	Marker Table: The default setting is Off. Tapping the marker table softkey turns ON the marker table function, displaying a marker table under the measurement display. The table is automatically sized to display all markers that are turned on. In addition to the marker frequency and amplitude, the table also shows the delta frequencies and amplitude deltas for all markers with delta frequencies.
Mark Table On Off	Counter: Opens the counter submenu, where users may set the frequency and precision of the frequency counter.
Counter >	Marker Noise: Tapping this key turns the markers into noise markers with units of dBm/Hz. When this option is selected, the detection method is automatically changed to RMS and the displayed value is compensated for the noise bandwidth of the resolution bandwidth filter.
Mark Noise ---	D-Noise: Sets the D-noise value. Use the rotary knob or data keypad to adjust.
D-Noise ---	Peak, More >: Opens a submenu of More Peak options, including Next Peak, Next Peak Left, Next Peak Right, Peak-Peak (navigates marker among peaks), Min Search (places marker at current lowest point on trace) and Peak Track (causes marker to follow the highest point of each sweep). Use these functions to move the active marker around the trace.
Peak, More >	All Off: Turns off all markers.
All Off	Prev Page: Returns to page 1 of the Marker menu.
Prev Page >	

17.1.6 Measurement setup menu (MeasSet)

NOTE: The functions present in the Meas Set menu depend on the measurement mode that is currently active. Check the Meas Set menu for tools specific to the application you are using.

	<p>Noise BW: Toggles the noise bandwidth function ON or OFF.</p>
	<p>NdB BW: Sets the noise bandwidth volume. Use the rotary knob or data keypad to adjust the value.</p>
	<p>Disp Line: Toggles the measurement line display ON or OFF.</p>
	<p>Disp Line: Sets the display line position. Use the rotary knob or data keypad to adjust the value.</p>

17.1.7 Trace menu (Trace)

	<p>Trace >: Select a trace. The instrument can display up to six traces: one with live data, and the other five with stored data or trace data math. To activate a specific trace, tap the desired trace button. Trace 1 is the default for spectrum analyzer operation and is denoted by yellow trace color. Each trace has a designated color, shown under the Trace setting box along the left edge of the display.</p>
	<p>Write: Continually sweeps and updates the current swept trace on the display.</p>
	<p>View: Displays the active trace.</p>
	<p>Blank: Turns off the active trace.</p>
	<p>Max Hold: Shows the cumulative maximum value of each display point over multiple sweeps of the active trace.</p>
	<p>Min Hold: Shows the cumulative minimum value of each display point over multiple sweeps of the active trace.</p>
	<p>Trace Math: tapping the Trace Math key opens the trace math dialog box of various mathematical operations, including power difference, power sum, log offset, and log difference. To close the dialog box, press the ESC button.</p>

	<p>Sample: This is the fastest detection method. For each display point, only one frequency point is measured. Use this method when speed is of greatest importance and the possibility of missing a narrow peak is not important.</p>
	<p>Posi-Peak: This method causes the largest measurement point to be shown for each display point, and assures that a narrow peak is not missed.</p>
	<p>Neg-Peak: This method causes the smallest measurement point to be shown for each display point. Typically, this mode is used to help detect small discrete signals in the presence of nearly equal values of noise. Display points containing only noise will tend to show lower amplitudes than those containing discrete signals.</p>
	<p>Normal: This method provides a better visual display of random noise than peak-detection, yet avoids the missed-signal problem of sample detection. Typically this mode is used to help detect small discrete signals in the presence of nearly equal values of noise. The display points that contain only noise will tend to show lower amplitudes than those that contain discrete signals.</p>
	<p>Avg: This method performs an average calculation of all the measurement points in each display point. This is particularly useful in displaying the integrated power, such as in a channel power measurement.</p>
	<p>RMS: This method performs a root-mean-square calculation of all the measurement points in each display point. This is particularly useful in displaying the average value of noise or noise like signals.</p>
	<p>Quasi-peak: This method makes resolution bandwidths and video bandwidths of 200 Hz, 9kHz, and 120 kHz available. This detection method is designed to meet CISPR requirements.</p>

17.1.8 Limit menu (Limit)

To access the functions under the Limit menu, press the **Limit** (#6) data key. The Limit menu keys are shown in the following tables.

Two types of limit lines can be specified: lower limit lines and upper limit lines. Limit lines can be used for visual reference only, or for pass/fail criteria. Limit failures are reported whenever a signal is above the upper limit line or below the lower limit line.

A limit line may consist of a single segment or as many as 40 segments. These limit segments are retained regardless of the current frequency span of the instrument, which allows the configuring of specific limit envelopes at various frequencies of interest – without having to re-configure them each time the frequency is changed.

	<p>Lmt_Up >:</p>
	<p>Limit: Toggle ON to set the upper limit (as defined in the Edit submenu).</p>
	<p>Upload: Copies saved upper limit data from a connected USB storage device to the instrument's internal memory.</p>
	<p>Download: Copies saved upper limit data from the instrument's internal memory to a connected USB storage device.</p>
	<p>Edit: Opens the Edit dialog and submenu, allowing you to manually specify upper limit values. See Section 33.2 for instructions.</p>

	Lmt_Down >:
	Limit: Toggle ON to set the lower limit (as defined in the Edit submenu).
	Upload: Copies saved lower limit data from a connected USB storage device to the instrument's internal memory.
	Download: Copies saved lower limit data from the instrument's internal memory to a connected USB storage device.
	Edit: Opens the Edit dialog and submenu, allowing you to manually specify lower limit values. See Section 33.2 for instructions.

17.2 Spectrum Analyzer One-Button Measurement Menus

The S5700 series field comm analyzer is equipped with Smart One-Button Measurements. These measurement tools are designed and configured to offer simple, powerful turn-key solutions to wireless signal field analysts. For directions on using each of these applications, see Chapters 19-23 (Channel Power through Harmonic).

One-button measurement options include:

- Channel Power
- Occupied Bandwidth (OCC BW)
- Adjacent Channel Leakage Ratio (ACLR)
- Field Strength
- Harmonic

To set up a One-Button Measurement, press the **Menu** button on the instrument's front panel. This will open the measurement mode desktop; tap the **Spectrum Analyzer** icon and then select from the available one-button measurement icons (Channel Power, OCC BW, ACLR, Field Strength or Harmonic) to activate them.

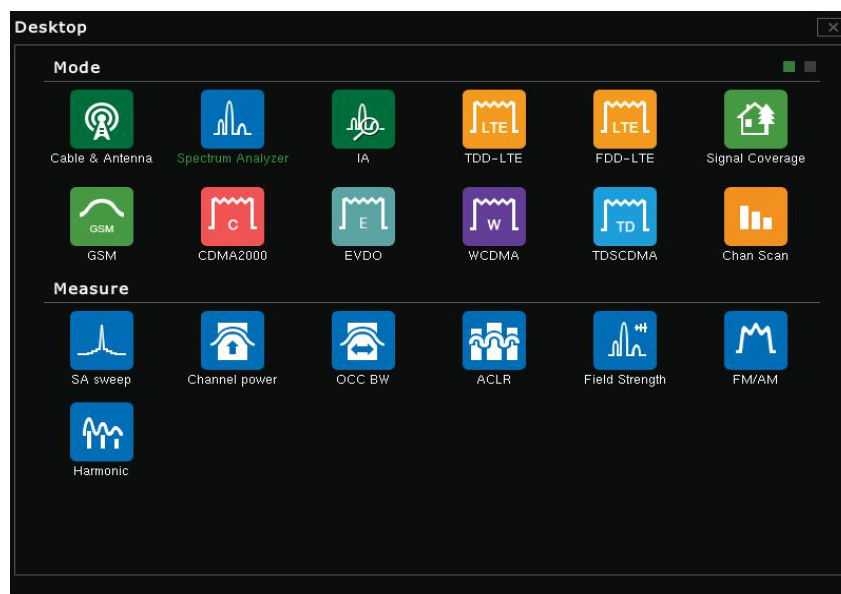



Fig.17.1 Desktop with one-button measurement modes available

17.2.1 Channel Power

When the **Channel Power** measurement is activated, channel power and power density will appear below the display, while the Channel Power measurement submenu will appear on the right edge of the display.

The detection method will also automatically change to RMS, as it provides the best measurement results and thus should be maintained. If you wish to modify the detection method, simply press the **Trace (#5)** key and tap the Detection submenu key.

Center frequency, span, and channel information will also appear below the display. These can be modified by tapping the Frequency main menu key located along the bottom edge of the display.

	Meas Set Submenu: Tapping the Meas Set softkey opens the Meas Set submenu.
	Integ BW: Sets the integration bandwidth for the channel power measurement.
	RF: Sets the RF trigger to Burst or Continuous (Free Run) mode.
	RF Burst: Opens the RF Burst submenu, where you can edit parameters of the burst signal.
Signal Standard: Tapping the Sig Std submenu softkey opens the Signal Standard submenu, enabling users to select a specific signal standard from the Select Signal list, as well as the specific channel number and respective link, downlink or uplink.	

	Burst RF: Tapping the Burst RF softkey opens the Burst RF submenu.
	Trig Slope: Sets the trigger polarity. Tap “Rise” to trigger on a rising edge, and “Fall” to trigger on a falling edge.
	Position: Sets the trigger line position. Adjust with the rotary knob or arrow keys. (With arrow keys, press Left/Right to adjust by 1 and Up/Down to adjust by 10.)
	Gate Delay: Controls the length of time from the time the gate condition goes True until the gate is turned on.
Next Page: Displays additional Burst RF options.	

	Gate RBW: Toggles Gate RBW mode from Auto to Manual (Manu) and vice-versa. On Auto, the instrument selects the res bandwidth based on the current span.
	Gate RBW: Manually set the gate resolution bandwidth. Use the arrow keys, rotary knob, or data keypad to adjust.
	Gate VBW: Toggles Gate VBW mode from Auto to Manual (Manu) and vice-versa. On Auto, the instrument selects the video bandwidth based on the current RBW.
	Gate VBW: Manually set the gate video bandwidth. Use the arrow keys, rotary knob, or data keypad to adjust.
Pulse Filter: Sets the pulse filter value. Use the arrow keys, rotary knob, or data keypad to adjust.	

17.2.2 Occupied Bandwidth (OCC BW)

When the **Occupied Bandwidth** measurement is activated, occupied bandwidth (OBW) and power density will appear below the display and the Occupied Bandwidth measurement submenu will be displayed on the right edge of the display.

The detection method will also automatically change to RMS, as it provides the best measurement results and thus should be maintained. If you wish to modify the detection method, simply press the **Trace (#5)** key and tap the Detection submenu key. Center frequency, span, and channel information will also appear below the display and can be modified by tapping the Frequency main menu key.

	Meas Set: Tapping the Meas Set softkey in OCC BW measurement mode opens the Occupied Bandwidth submenu.
	Integ BW: Sets the integration bandwidth for the channel power measurement.
	OBW Power: Sets the percentage of power for calculating the occupied BW.
	X dB: Sets the dB Down level for calculating the occupied BW.
	RF: Sets the RF trigger to Burst or Continuous (Free Run) mode. The default setting is Continuous.
	Burst RF: Opens the Burst RF submenu if RF is toggled to Burst.

	Burst RF: Tapping the Burst RF softkey opens the Burst RF submenu.
	Trig Slope: Sets the trigger polarity. Tap “Rise” to trigger on a rising edge, and “Fall” to trigger on a falling edge.
	Position: Sets the trigger line position. Adjust with the rotary knob or arrow keys. (With arrow keys, press Left/Right to adjust by 1 and Up/Down to adjust by 10.)
	Gate Delay: Controls the length of time from the time the gate condition goes True until the gate is turned on.
	Next Page: Displays additional Burst RF options.

	Gate RBW: Toggles Gate RBW mode from Auto to Manual (Manu) and vice-versa. On Auto, the instrument selects the res bandwidth based on the current span.
	Gate RBW: Manually set the gate resolution bandwidth. Use the arrow keys, rotary knob, or data keypad to adjust.
	Gate VBW: Toggles Gate VBW mode from Auto to Manual (Manu) and vice-versa. On Auto, the instrument selects the video bandwidth based on the current RBW.
	Gate VBW: Manually set the gate video bandwidth. Use the arrow keys, rotary knob, or data keypad to adjust.
	Pulse Filter: Sets the pulse filter value. Use the arrow keys, rotary knob, or data keypad to adjust.

17.2.3 Adjacent Channel Leakage Ratio (ACLR)

When the **ACLR** measurement is activated, ACLR information will appear below the display and the ACLR measurement submenu will be displayed on the right edge of the display. The detection method will also automatically change to RMS, as it provides the best measurement results and thus should be maintained. However, if you wish to modify the detection method, press **Trace (#5)** and open the Detection submenu.

Center frequency, span, and channel information will also appear below the display and can be modified by tapping the Frequency main menu key located along the bottom edge of the display.

	<p>Meas Set: Tapping the Meas Set softkey opens up a dialog box enabling the user to setup the ACLR measurement. (See below.) Within this dialog, you can set signal standard, bandwidth values, and other specifications.</p>
---	---



Fig.17.2 ACLR measurement setting interface

17.2.4 Field Strength

When the **Field Strength** measurement is activated, the reference level units will automatically change from dBm to dBμV/m.

The detection method will also automatically change to Positive Peak (POS), as it provides the best measurement results and thus should be maintained. However, if you choose to modify the detection method, simply press the **Trace (#5)** key and tap the Detection submenu key.

Center frequency, span, and channel information will also appear below the display and can be modified by tapping the Frequency main menu key located along the bottom edge of the display.

	<p>Antenna Select: This submenu key brings up a dialog box that lists all the antennas for which the instrument has data, including both standard antenna and custom antennas that have been added using the Saluki Software Tools. Use the Up or Down arrow to select the desired antenna.</p>
	<p>Antenna Manager: Tap this softkey to open the Antenna submenu.</p>

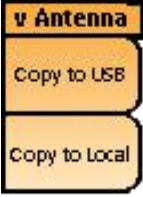
	<p>Copy to USB: Copies antenna files saved on internal memory to external storage. A USB memory stick must be connected to the instrument.</p>
	<p>Copy to Local: Copies antenna files saved on external storage to internal memory. A USB memory stick must be connected to the instrument.</p>

17.2.5 Harmonic

When the **Harmonic** measurement is activated, the reference level units will automatically change from dBm to dB μ V/m.

The detection method will also automatically change to Positive Peak (POS), as it provides the best measurement results and thus should be maintained. However, if you choose to modify the detection method, simply press the **Trace** (#5) key and tap the Detection submenu key.

Center frequency, span, and channel information will also appear below the display and can be modified by tapping the Frequency main menu key located along the bottom edge of the display.

	<p>Fundament: Sets the fundamental frequency for the current measurement.</p>
	<p>Harmonic Number: Sets the harmonic number. For example, a value of 3 would indicate the third harmonic.</p>
	<p>Signal: Toggles the signal setting between Analog (Ana) and Digital (Digi).</p>
	<p>Integ BW: Sets the integration bandwidth, the range of integration used in calculating the power in the channel. Use the arrow keys, rotary knob, or data keypad to adjust.</p>

Chapter 18 Spectrum Analyzer

Introduction

This chapter provides an overview of making spectrum analyzer measurements.

The following sections will highlight the typical setup for performing basic spectrum analysis measurements. In general, spectrum analyzer measurements include the use of frequency, span and amplitude as the primary control functions for spectrum analysis measurements.

Other important control functions will offer the user a deeper view of the signal environment. These include setting **resolution and video bandwidth**, **input attenuation**, and **sweep functions** in order to effectively tune the spectrum analyzer to identify and analyze the signal environment – for either known or unknown signals.

Marker functions and limit lines can be employed to aid in the analysis of the signal environment. In some cases, users may employ smart one-button measurements that come standard with the S5700 series's spectrum analyzer function. These include **Channel Power**, **Occupied Bandwidth**, **Adjacent Channel Leakage Ratio**, **Field Strength**, and **Harmonic** measurements to evaluate the signal environment.

In other cases, users may employ optional measurement licenses for specific measurement applications, including **Interference Analysis**, **Signal Coverage Mapping**, **Base Station Measurements**, **Base Station Air Interface Measurements**, **RF Power Meter** and **Tracking Generator** measurements. This user manual will only focus on the standard spectrum analyzer measurements and set-ups, as well as Interference Analysis, Signal Coverage Mapping, RF Power Meter and Tracking Generator measurements. Base Station measurements will be covered in a separate Measurement Guide.

Sections 18.1 through 18.4 cover setup procedures & settings for making spectrum analyzer measurements. Sections 18.3 through 18.6 cover resolution and video bandwidth, sweep, attenuator, & detection functions.



Fig.18.1 Spectrum analyzer function interface

18.1 Setting Up Spectrum Analyzer Measurements

18.1.1 Setting frequency & span parameters

The frequency (or span) parameters set the active tuning range of the instrument – essentially telling the spectrum analyzer how wide the “window” of frequency we want to view is. The wider the frequency range (or span), the slower the sweep speed.

To set the frequency parameters, press the **Frequency** main menu key located along the bottom edge of the display. This opens the Span and Frequency submenus, located along the right hand side of the display.

The tuning frequency range can be entered in several different ways, depending upon what makes the most sense – either for the user or for the application:

- The center frequency and span can be specified
- The start and stop frequencies can be entered
- A signal standard and channel number can be selected from the built-in list

18.1.2 Setting amplitude parameters

The amplitude parameters set the instrument’s ability to accurately detect the power level of the signal of interest. To set the amplitude parameters, press the **Amplitude** main menu key located along the bottom edge of the display. This opens the Amplitude submenu, located along the right-hand side of the display.

To properly set the amplitude reference level, the user must have a sense of the signal power level that the user wishes to detect. Cellular BTS signals are generally around -100dBm, but may be higher or lower, depending on the type of signal. For the best accuracy, the peak signal level tip should touch the second grid line down from the top edge of the display. To position the signal at this level, you may have to adjust the reference level and input attenuation (normally in Auto mode) a few times. Additionally, you may have to adjust the scale (normally set to 10dB/div).

18.1.3 Setting bandwidth parameters

Both resolution bandwidth (RBW) and video bandwidth (VBW) can be coupled to the frequency span and automatically or manually set. When set to Auto RBW, the RBW adjusts automatically in proportion to the frequency span. The default ratio of the span width to the resolution bandwidth is 100:1.

- When auto-coupling between the span and RBW is selected (the Auto RBW submenu key is toggled “On”), this is indicated on the left side of the display with the RBW label. Underneath this label are one to three digits, followed by the frequency units; this represents the resolution bandwidth value.
- When manual RBW is selected (the Auto RBW submenu key is toggled “Off”), the label and value turn red and a ‘#’ symbol is shown in front of the RBW label.

Adjust resolution bandwidth independently of the span. If an unavailable resolution bandwidth is entered, then the instrument selects the next higher resolution bandwidth. If a value greater than the widest RBW is entered, then the widest RBW will be selected.

VBW can also be set two ways – manually or by auto-coupling. With auto-coupling, the video bandwidth becomes linked to the resolution bandwidth, so that VBW varies in proportion to RBW.

- As with RBW, auto-coupling is indicated on the left side of the display with the VBW label. Underneath this label are one to three digits followed by the frequency units; this represents the video bandwidth value.
- When manual VBW coupling is selected, the label and value turn red and the “#” symbol is shown in front of VBW on the left side of the display.

Adjust video bandwidth independently of the RBW. If a non-existent video bandwidth is entered, then the instrument will select the next higher video bandwidth. If a value greater than the widest VBW is entered, then the widest VBW will be selected.

The ratio of the resolution bandwidth to the video bandwidth can be changed by pressing the BW main menu key, then the RBW/VBW submenu key, and finally using the keypad, the directional arrows, or the rotary knob to set the ratio. By default, the RBW/VBW ratio is set to 3. The current value of the ratio is shown as part of the submenu key label.

The RBW range varies with instrument features. Refer to the RBW description in subsection 18.1.3, and check your Technical Data Sheet for the RBW range in your instrument.

18.1.4 Setting sweep parameters

To set the sweep parameters, press the **Sweep (#3)** key.

Single/Continuous

When this submenu key is pressed, the instrument toggles between single sweep and continuous sweep. In single sweep mode, after the sweep, the instrument waits in Hold mode until the **Run/Hold (+/-)** key is pressed.

Sweep Mode

Several sweep modes are available on the instrument. Press the Sweep Mode submenu keys to select between **Fast**, **Performance (default)**, or **No FFT**. Improperly installed cellular boosters can produce interference that is sometimes bursted. Some bugs use burst transmission to make them hard to find. By using Burst Detect mode, a narrow-pulsed or bursty signal is easily seen in Spectrum Analyzer Mode.

Emitters as narrow as 200µs can be captured every time. FFT (featuring quick burst detect) works within a maximum span of 20 MHz.

The Show Help submenu key displays a table detailing the trade-off between sweep speed and performance of the sweep mode options.

18.1.5 Trigger type

To select a specific type of triggering in zero span, press the **Triggering** submenu key followed by the **Source** submenu key. Selections include:

- Free Run (default trigger type). The instrument begins another sweep as soon as one is finished.

- Video. This mode is used in zero span to set the power level at which a sweep is initiated. The power level can be set from -130 dBm to +30 dBm. Trigger is based on the measured signal level. The sweep triggers when the signal level crosses the trigger level with a positive slope. If no signal crosses the trigger level, the last trace on the screen (before video triggering was selected) will be displayed. To change the video triggering level use the rotary knob, enter the desired amplitude with the keypad, or use the left or right arrows to change the setting by 1 dB or the up or down arrows to change the setting by 10 dB.

You can select Normal, or any one of four fixed IF bandwidths: 7MHz, 10MHz, 16MHz, or 32MHz.

In Normal, the bandwidth is set by the spectrum analyzer RBW selection ($BW > \text{Zero Span RBW}$). When Normal is selected, the IF bandwidth is influenced by the selection of RBW filters, although the digital RBW filters themselves are not employed.

Zero Span IF output effectively uses the spectrum analyzer as a receiver front-end, converting the input signal at the spectrum analyzer RF In connector to a signal centered at 140MHz out of the IF Out 140MHz connector. You can then process the IF signal in a way that meets your needs. This may require an A-to-D converter or some other signal processing method.

An anti-aliasing filter can be employed in the signal processing to reduce the effect of noise and spurious signals. A filter centered on 140MHz with a bandwidth slightly wider than 32MHz is also advised, to eliminate any undesired out-of-band signals on the IF output. In particular, signals at 100MHz and its harmonics (that would be eliminated by the filter) are on the IF output.

18.2 Additional Measurement Parameters

18.2.1 Resolution bandwidth

Resolution Bandwidth (RBW) determines frequency selectivity. The spectrum analyzer traces the shape of the RBW filter as it tunes past a signal. The choice of resolution bandwidth depends on several factors.

Filters take time to settle. The output of the filter will take some time to settle to the correct value, so that it can be measured. The narrower the filter bandwidth (resolution bandwidth) the longer the settling time needs to be, and therefore, the slower the sweep speed.

The choice of resolution bandwidth will depend upon the signal being measured. If two closely-spaced signals are to be measured individually, then a narrow bandwidth is required. If a wider bandwidth is used, then the energy of both signals will be included in the measurement. Thus, the wider bandwidth does not have the ability to look at frequencies selectively, but instead simultaneously measures all signals falling within the resolution bandwidth. Therefore, a broadband measurement would include all signals and noise within the measurement bandwidth into a single measurement.

On the other hand, a narrow-band measurement will separate the frequency components, resulting in a measurement that includes separate peaks for each signal. There are advantages to each. The ultimate decision will depend upon the type of measurement required.

There is always some amount of noise present in a measurement. Noise is often broadband in nature; that is, it

exists at a broad range of frequencies. If the noise is included in the measurement, the measured value could be in error (too large) depending upon the noise level. With a wide bandwidth, more noise is included in the measurement.

With a narrow bandwidth, less noise enters the resolution bandwidth filter, and the measurement is more accurate. If the resolution bandwidth is narrower, the noise floor will drop on the spectrum analyzer display. As the measured noise level drops, smaller signals that were previously obscured by the noise can now be measured.

18.2.2 Video bandwidth

Spectrum analyzers typically use another type of filtering after the detector. This is called video filtering. This filter also affects the noise on the display, but in a different manner from the resolution bandwidth.

In video filtering, the average level of the noise remains the same, but the variation in the noise is reduced. Hence, the effect of video filtering is a “smoothing” of the signal noise. The resultant effect on the analyzer’s display is that the noise floor compresses into a thinner trace, while the average position of the trace remains the same.

Changing the video bandwidth (VBW) does not improve sensitivity, but it does improve discernibility and repeatability when making low-level measurements. As a general rule of thumb, most field spectrum analyzer measurements are made at a video bandwidth that is a factor of 10 to 100 less than the resolution bandwidth. This ratio can be specified in the BW main menu.

Using this ratio, with a resolution bandwidth of 30kHz, typically, the video bandwidth is set between 300Hz to 3kHz, although it can be set anywhere from 1 Hz to 10MHz.

18.2.3 Sweep limitations

With some spectrum analyzers, the user has control over sweep time (the elapsed time of each sweep, sometimes called scan time). An analyzer cannot be swept arbitrarily fast while maintaining its specified accuracy, but will have a sweep rate limitation depending upon the resolution bandwidth, video bandwidth, and frequency range selected. The sweep rate is NOT usually chosen by the user, but is determined by the frequency range swept divided by the sweep time.

The limitation on sweep rate comes from the settling or response time of the resolution and video bandwidth filters. If an analyzer is swept too quickly, the filters do not have time to respond, and the measurement is inaccurate. Under such conditions, the analyzer display tends to have a “smeared” look to it, with the spectral lines being wider and at a lower amplitude than normal, and shifted to the right.

Fortunately, S5700 series is designed to relieve the user from having to calculate the sweep speed or experiment to discover a sweep speed that yields accurate results. When changing the RBW and VBW, the sweep speed automatically changes to the fastest sweep speed that will yield accurate results. The sweep speed will be faster for a wide RBW or VBW and slower for a narrow RBW or VBW.

The sweep speed can also be changed manually, by pressing the Sweep key and selecting the Sweep Time submenu key. Enter a sweep time from 10 μ s to 600 seconds. If the minimum sweep time entered by the user is less than the value needed to assure accurate results, the value that delivers accurate results will be used. Regardless of

the minimum sweep time setting, the instrument will never sweep faster than the RBW and VBW settings allow. The instrument is designed to ensure that no uncalibrated measurement conditions will occur.

18.2.4 Attenuator functions

The S5700 series include a step attenuator at the RF input. This attenuator is used to reduce large signals to levels that make best use of the analyzer's dynamic range. Normally, the input attenuation automatically adjusts as a function of Reference Level. In the Amplitude menu, the Attenuation submenu allows manual setting of the attenuator.

- In **Auto Atten** mode, as the reference level is increased, the attenuation is increased.
- In **Manual** mode, the input attenuation can be adjusted using the keypad, the up or down arrow keys, or the rotary knob.

18.2.5 Detection

Several detection methods tailor the performance of the instrument to meet specific measurement requirements. In general, several measurement points are calculated for each display point. The following detection methods allow the user to control how measurement point data is shown at each display point.

To set a detection method, press **Trace (#5)** and open the **Detection** submenu.

- **Sample:** This is the fastest detection method. For each display point, only one frequency point is measured. Use this method when speed is of greatest importance, and the possibility of missing a narrow peak is not important.
- **Posi-Peak:** This method causes the largest measurement point to be shown for each display point, and assures that a narrow peak is not missed.
- **Neg-Peak:** This method causes the smallest measurement point to be shown for each display point. Typically, this mode is used to help detect small discrete signals in the presence of nearly equal values of noise. The display points that contain only noise will tend to show lower amplitudes than those that contain discrete signals.
- **Normal:** This method provides a better visual display of random noise than peak-detection, but avoids the missed-signal problem of sample detection. Typically, this mode is used to help detect small discrete signals in the presence of nearly equal values of noise. The display points that contain only noise will tend to show lower amplitudes than those that contain discrete signals.
- **Avg:** This method performs an average calculation of all the measurement points in each display point. This is particularly useful in displaying the integrated power, such as in a channel power measurement.
- **RMS:** This method performs a root-mean-square calculation of all the measurement points in each display point. This is particularly useful in displaying the average value of noise or noise-like signals.
- **Quasi-peak:** When this selection is made, resolution bandwidths and video bandwidths of 200 Hz, 9 kHz, and 120 kHz are available. This detection method is designed to meet CISPR requirements.

18.2.6 Preamplifier operation

The preamplifier can be turned on and off by pressing the **Amplitude** main menu key, selecting the Attenuation submenu, and (under Pre Amp) tap **On** or **Off**. The Preamplifier is standard in both the S5700A and S5700B. Notice that when the preamplifier is turned on, the noise floor drops significantly.

Smart One-Button Measurements

Aside from the base Spectrum Analyzer measurement application (SA Sweep), additional measurement applications can be added to the S5700 series analyzer's functionality – either at the time of purchase, or at a later date as your test needs evolve.

The following chapters provide an overview of these optional measurement applications:

- Channel Power (Chapter 19)
- Occupied Bandwidth (Chapter 20)
- Adjacent Channel Leakage Ratio (Chapter 21)
- Field Strength (Chapter 22)
- Harmonic (Chapter 23)

You can access software-enabled spectrum analysis applications by pressing the **Menu** button to the top- right of the display, tapping the **Spectrum Analyzer** icon, then selecting from the icons in the bottom pane.

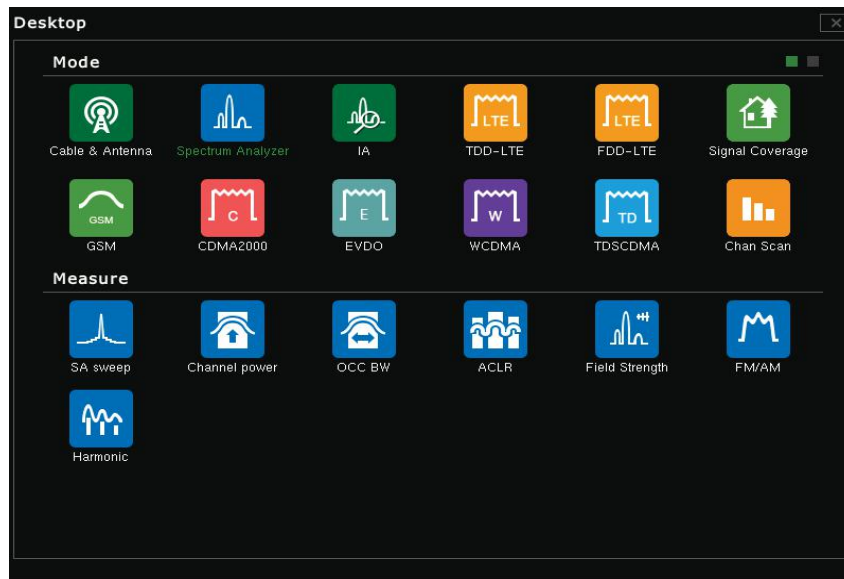

Chapter 19 Channel Power

Introduction

Channel power measurement is one of the most common measurements for a radio transmitter. This test measures the output power of a transmitter over the frequency range. Out-of-spec power measurements indicate system faults, which can be in the power amplifiers or in filter circuits. These measurements can be used to validate transmitter performance, comply with government regulations, or to minimize interference.

Setting Up the Channel Power Measurement

Procedure:

1. Press the **Menu** key and tap **Spectrum Analyzer** in the desktop. Below, tap **Channel power**.
2. Press the **Frequency** main menu key and open the **Frequency** submenu.
3. Press the **Sig Std** submenu key. Toggle **On**, then choose the desired standard and press Enter.
4. Press the **Channel #** submenu key to enter the channel number for the measurement.
5. Press the **Meas Set** main menu key and set the integrated channel bandwidth (**Integ BW**). This value is proportional to Span, which will auto-adjust if Integ BW is changed.
6. Press **RF Burst / Cont** to toggle between bursts (best used for GEM, TD-LTE, wi-fi, or other TDD signals) and continuous signal (best used for broadcasting signals).
7. If using **Burst**, you can adjust parameters in the **Burst RF** submenu, See subsection 17.2.1 for more details.
8. The instrument will automatically take channel power measurements. View results below the display.

Channel Power Measurement for GSM

Global Systems for Mobile (GSM) communication is a globally accepted standard for digital cellular communication. A number of frequency bands that are allocated to GSM mobile phones use a combination of Frequency Division Multiple Access (FDMA) and Time Division Multiple Access (TDMA). Within each band are approximately one hundred available carrier frequencies on 200 kHz spacing (FDMA), and each carrier is broken up into time-slots so as to support eight separate conversations (TDMA). GSM uses the Gaussian Minimum Shift Keying (GMSK) modulation method.

The following procedure requires: Test Port extension cable.

1. Using the test port extension cable, connect the signal source to the RF In test port.
2. Press the **Amplitude** main menu key and press the **Reference Level** submenu key to set the reference level to -20 dBm. Adjust the values given in this procedure to match your measurement conditions.
3. Press the **Scale** submenu key and set the scale to 10 dB/div.
4. Press the **BW** main menu key and verify that RBW and VBW are set to **Auto**.
5. Press the **Frequency** main menu key followed by the **Signal Standard** submenu key. Turn Signal Tab On

and tap Select Signal. Scroll through the dialog box using the up or down arrow keys or the rotary knob to highlight the GSM 900 - Downlink standard for the measurement and press Enter.

6. Press the **Channel#** submenu key and enter the channel number using the keypad, the arrow keys, or the rotary knob. For this example, select Channel 60.

7. Verify that the center frequency is set to that of the GSM signal (in this case, 947.0MHz).

8. Press the **Meas Set** submenu key. Tap **Integ BW** (Integration Bandwidth) and enter 200kHz, or set the integration bandwidth appropriate for the particular application.

9. Back in the **Frequency** menu, press the **Span** submenu key and enter 600kHz as the channel span, or set the channel span to a value appropriate for the particular application.

10. The instrument will automatically take channel power measurements. View results on the display.

Channel power is a constant measurement. After it is turned on, it will remain on until it is turned off by pressing the On/Off submenu key again.

Chapter 20 Occupied Bandwidth (OCCBW)

Introduction

Occupied Bandwidth (OBW) is a common measurement performed on radio transmitters. This measurement calculates the bandwidth containing the total integrated power occupied in a given signal bandwidth (typically 99%). There are two different methods of calculation depending upon the technique used to modulate the carrier.

- **% Integrated Power Method.** The occupied frequency bandwidth is calculated as the bandwidth containing the specified percentage of the transmitted power.
- **dBc Method.** The occupied frequency bandwidth is defined as the bandwidth between the upper and lower frequency points at which the signal level is a desired number of dB below the peak carrier level.

To determine the amount of spectrum used by a modulated signal, the Occupied Bandwidth measurement shows both power across the band and power bandwidths in a user-specified percentage. Occupied bandwidth is typically calculated as the bandwidth containing 99% of the transmitted power.

The following procedure requires: Test Port Extension Cable and Attenuator (30 dB, 50 Watt, bi-directional, DC –8.5 GHz, N(m) – N(f)).

Setting Up the Occupied Bandwidth Measurement

Procedure:

1. Press the **Menu** key and tap Spectrum Analyzer in the desktop. Below, tap **OCC BW**.
2. Press the **Meas Set** menu key.
3. Set **OBW Power %**. The default value is 99%. To set to a different OBW Power %, press the OBW Power submenu and enter the desired %. Press **Enter** button.
4. Set **X dB** bandwidth measurement. The default is -3dB. The X dB BW can also be changed by pressing the X dB submenu key and entering the desired level. Press **Enter** button.
5. To set the channel bandwidth, select **Integ BW**. The default channel BW is 8MHz. In order to measure more accurately, the span frequency is set to 1.5 times the channel bandwidth (the channel bandwidth is proportional to the span; therefore the span will change according to the channel BW value. You can modify the channel BW by pressing Integ BW and entering a value via the data keypad, arrow keys, or rotary knob.

Making the Occupied Bandwidth Measurement

Procedure:

6. Using the test port extension cable and the 30 dB, 50 watt, bi-directional attenuator (if needed), connect the RF In port to the appropriate transmitter test port or signal source.
7. Press the **Frequency** main menu key followed by the **Center Freq** submenu key. Enter the center frequency using the keypad, the arrow keys, or the rotary knob. If entering a frequency using the keypad, the submenu key labels change to GHz, MHz, kHz, and Hz. Press the appropriate units key. (Pressing the Enter key

has the same effect as the MHz submenu key.)

8. If an attenuator was connected in Step 1, then open the **Amplitude** menu and **RL Offset** submenu. Enter 30, then select **dB External Loss** to compensate for loss in the attenuator.

9. Open the **Amplitude** main menu, then tap **Ref Level** to set the appropriate reference level.

10. Press the **Atten Lvl** submenu key to set the input attenuation level or leave **Auto Atten** set to On.

11. Press the **BW** main menu key to set the resolution bandwidth and video bandwidth if desired.

12. Finally, press the **Limit (#6)** button and tap **Limit** to open the limit dialog. From this window, you can set different types of limits relating to the previously modified parameters. The measurement must keep within all limits to be considered a “pass”.

Occupied Bandwidth is a constant measurement; after it is turned on, it remains on until it is turned off by pressing the On/Off submenu key again. Occupied bandwidth is calculated at the end of each sweep.

Chapter 21 ACLR

Introduction

Adjacent Channel Leakage Ratio (ACLR) refers to the power ratio between the main channel and adjacent channels. The S5700 series have the ability to measure to perform single-channel or multi-channel ACLR testing. Multi-channel testing helps you to measure ACLR in a multi-channel transmitting base station.

The following procedure requires: Test Port Extension Cable and Attenuator (30 dB, 50 Watt, bi-directional, DC –8.5 GHz, N(m) – N(f)).

Note that, when selecting a specific signal standard (e.g. LTE), many of the ACLR measurement settings are automatically selected. The procedure below will guide you through ACLR setup if you prefer to perform ACLR measurements in spectrum analyzer (SA) mode, or simply provide you with a background of the setup functions.

Setting Up the ACLR Measurement

Procedure:

1. Press the **Menu** key and tap **Spectrum Analyzer** in the desktop. Below, tap **ACLR**.
2. Set up the single or multi-channel ACLR measurement. Press the **Meas Set** menu key and open the **Meas Set** submenu, then open the ACLR settings dialog box.
3. Use the touchscreen softkeys, data keypad, arrow keys, and rotary knob to select and modify the **Sig Std**, **Carrier BW**, **Num**, **Resolution BW**, **Adjacent BW**, and **Offset** values. You can also toggle the **RMS** (Root Mean Square) calculation on or off.
 - a. Select **Sig Std** (signal type) to set the ACLR measurement to SA (spectrum analysis; default mode), or one of the various signal standards. Press **OK** to confirm.
 - b. Select **Carrier BW** only if you have selected SA Sig Std. If you have selected one of the various signal standards, the Carrier BW will be automatically selected based on the signal standard. Press **OK** to confirm.
 - c. Select **Num** to define the number of main channels to measure during your ACLR test. You can select up to twelve (12) channels to measure simultaneously. Press **OK** to confirm.
 - d. Select **Res BW** (RBW). Generally, the RBW is automatically coupled to the signal standard you have selected (equally true for SA Sig Std). If you prefer to set the RBW to a different setting, you have elected to de-couple the auto RBW setting to manual mode, which will show a # symbol in the RBW summary box to the left of the display. Press **OK** to confirm.
 - e. Select **ADJ BW** only if you have selected SA Sig Std. If you have selected one of the various signal standards, the Adj BW will be automatically selected based on the signal standard and should be the same as the Carrier BW. Press **OK** to confirm.
 - f. Select **Adj Num** to define the number of adjacent channels you want to test. You can select up to six (6) adjacent channels that can be measured simultaneously. Press **OK** to confirm. The adjacent channel offsets (Offset #) will automatically be selected.

- g. Select **Offset 1** only if you have selected SA Sig Std. If you have selected one of the various signal standards, the Offset 1 will be automatically selected based on the signal standard and the number of adjacent channels you selected (Adj Num). The offset will show both upper and lower (or left and right) adjacent channels. Press **OK** to confirm.
 - h. Select **Ref Car** (reference carrier) to define the reference carrier and hence the basis of the ACLR measurement. For example, if you have selected three carriers (Num) for a multi-channel measurement, select the carrier 1, 2 or 3 to be the reference carrier for the ACLR test (it should be noted that Auto is the default setting). Press **OK** to confirm.
 - i. Select **RMS** to False if you are making carrier or general wireless network ACLR measurements. If you are making ACLR measurements on a TV Broadcast you will want to change the RMS setting to True. Press **OK** to confirm.
4. Save your settings and resume measurement by pressing the **OK** submenu key.
 5. To establish your ACLR Pass/Fail conditions, press the **Limit** button on the data keypad (#6).
 - a. For each adjacent channel, you have the option of activating its respective Pass/Fail condition by simply selecting **State** to On or Off. Press OK to confirm.
 - b. Next, select the Pass/Fail Mode. **Abs** (absolute), **Rel** (relative), **And** (both absolute and Rel), and **Or** (either absolute or relative). Relative is the most common mode used for ACLR measurements. Press OK to confirm.
 - c. Next, set the limit line Pass/Fail **Rel** (relative) and **Abs** (absolute) parameter by entering in the desired (or specified) parameter. Press OK to confirm.

Making the ACLR Measurement

Procedure:

6. Using the test port extension cable and 30 dB attenuator, connect the signal source to the input of the attenuator, and connect the output of the attenuator to the **RF In** test port.
7. If an attenuator was connected in step 1, press the **Amplitude** main menu key then press the **RL Offset** submenu key. Enter 30, then select dB External Loss to compensate for loss in the attenuator.
8. Press the **Amplitude** main menu key and press the **Reference Level** submenu key to set the reference level to 60 dBm.
9. Press the **Atten Lvl** submenu key to set the input attenuation level needed for the measurement. This value depends on the input power level and any external attenuator. Enter an attenuation level to achieve roughly -40 dBm at the input mixer.
10. Press the **BW** main menu key and verify that RBW and VBW are set to **Auto**.
11. There are two ways to set the measurement parameters.
 - a. If the signal standard and channel are known: press the **Frequency** main menu key, set the signal standard, and press **Channel** for the signal to be measured. Skip to Step 12.

b. If the signal standard and channel are not known: continue to Steps 7 through 11.

12. Press the **Frequency** main menu key, press the **Center Freq** submenu key, and enter the desired center frequency.

Solid vertical lines are drawn on the display to indicate the main channel, while dashed vertical lines define the adjacent channels. The SPA will display the measurement results in the message area.

Adjacent Channel Power Ratio is a constant measurement. After it is turned on, it will remain on until it is turned off by pressing the On/Off submenu key again.

Chapter 22 Field Strength

Introduction

The following procedure requires: Portable Antenna for which antenna factors or antenna gain & bandwidth data are available.

Setting Up the Field Strength Measurement

Procedure:

1. Press the **Menu** key and tap **Spectrum Analyzer** in the desktop. Below, tap **Field Strength**.
2. Connect the antenna to the RF In port.
3. Press the **Meas Set** menu key. Then press the **Antenna** submenu key to display the loaded antenna profiles with their model number and frequency range. Use the up or down arrow keys or the rotary knob to select the desired antenna. Press the Enter key to select, or ESC to cancel.
4. Press the **Freq** main menu key, press the **Center Freq** submenu key, and enter the center frequency.
5. Press the **Span** main menu key. Set the span wide enough to include primary channel bandwidth and upper and lower channel bandwidths. At least a portion of the span has to include a frequency within the antenna's specified range.
6. Press the **BW** main menu key and verify that RBW and VBW are set to **Auto**.
7. To change the units of measurement, press the **Amplitude** main menu key, then press the **Units** submenu key and select from the following: dBm/m², dBV/m, dBmV/m, dBμV/m, Volt/m, Watt/m², dBW/m², A/m, dBA/m, or Watt/cm². The instrument automatically adjusts the measurement by the antenna factors selected. Marker values are displayed in the same units as selected for amplitude.

Antenna Calculations

The following is a helpful reference list of various antenna calculations, should you find it necessary to convert from one parameter to another.

Conversion of signal levels from watts to volts in a 50 ohm system:

$$P = V^2/R$$

where:

P = power in Watts

V = voltage level in Volts R = resistance in ohms

Note that 1mW = 10⁻³ W and 1 μV = 10⁻⁶ V. For power in dBm, and voltage in dB (μV): VdB(μV) = P(dBm) + 107 dB

Power density to field strength:

An alternate measure of field strength is power density: Pd = E² / 120m²

where:

E = field strength in V/m

Pd = Power density in W/m²

Power density at a point:

$Pd = PtGt / (4\pi r^2)$

This equation is only valid in the far field, where electric and magnetic fields are related by the characteristic impedance of free space:

where:

Pd = power density in W/m

Pt = power transmitted in Watts Gt = gain of transmitting antenna

r = distance from the antenna in meters

Chapter 23 Harmonic

Introduction

The Harmonic measurement application can measure multi-order harmonic levels and total harmonic distortion (THD) of the signal.

Setting Up the Harmonic Measurement

Procedure:

1. Press the **Menu** key and tap **Spectrum Analyzer** in the desktop. Below, tap **Harmonic**.
2. Press the **Frequency** main menu key followed by the **Center Freq** submenu key. Enter the center frequency using the keypad, the arrow keys, or the rotary knob. If entering a frequency using the keypad, the submenu key labels change to GHz, MHz, kHz, and Hz. Press the appropriate units key. (Pressing the Enter key has the same effect as the MHz submenu key.)
3. Press the **Amplitude** main menu key then press the **Reference Level** submenu key to set the appropriate reference level.
4. Press the **Atten Lvl** submenu key to set the input attenuation level or leave **Auto Atten** set to On.
5. Press the **BW** main menu key to set the resolution bandwidth and video bandwidth if desired.
6. Press the **Meas Set** menu key. Tap **Fundament** and use the data keypad or rotary knob to adjust the fundamental frequency.
7. Under **Signal**, tap **Ana** or **Digi** to toggle between digital and analog signal measurement.
8. Tap **Harmonic Number** and use the data keypad or rotary knob to indicate the order of harmonics to display. Notice that the measurement display adds or subtracts graphs to indicate each harmonic. You can enter a maximum value of 10.
9. Tap **Integ BW** to set the integrated bandwidth for each harmonic signal.
10. To change the units of measurement, press the **Amplitude** main menu key, then press the **Units** submenu key and select from the following: dBm/m², dBV/m, dBmV/m, dB μ V/m, Volt/m, Watt/m², dBW/m², A/m, dBA/m, or Watt/cm². The instrument automatically adjusts the measurement by the antenna factors selected. Marker values are displayed in the same units as selected for amplitude.

Chapter 24 Additional Field Measurements

24.1 Out-of-band Spurious Emission Measurement

The following procedure requires: Test Port Extension Cable.

Procedure:

1. Using the test port extension cable, connect the signal source to the **RF In** test port.
2. Press the **Frequency** main menu key, press **Center Freq**, and enter the center frequency.
3. Press the **Span** main menu key. Set the span wide enough to include the primary channel bandwidth and upper and lower channel bandwidths.
4. Press the **Amplitude** main menu key, then tap **Reference Level**. Set the reference level to -20 dBm.
5. Press the **Auto Atten** submenu key set the attenuation to **On**.
6. Press the **BW** main menu key, then use the **RBW** and **VBW** submenu keys to set the resolution bandwidth to 3 kHz and the video bandwidth to 300 Hz.
7. Press the **Marker** main menu key and press the **Select Marker** submenu key to select Marker 1. The green-highlighted number indicates the active marker.



Fig.24.1 Marker setting interface

8. Press the **On/Off** submenu key to activate the marker. Use the arrow keys, the keypad, and the knob to move the marker over one of the spurs. To use the corresponding delta marker, toggle **Delta** to **On**. Use the rotary knob to move the delta marker to the desired frequency. Press **Enter**.
9. Compare the value of the marker to the specified allowable level of out-of-band spurious emissions for the corresponding channel transmit frequency.
10. Repeat Step 8 and Step 9 for the remaining spurs. Either re-use Marker 1, or choose another marker.

24.2 In-band / Out-of-Channel Measurements

The in-band/out-of-channel measurements measure distortion and interference within the system band, but outside of the transmitting channel. These measurements include in-band spurious emissions and adjacent channel power ratio (also called spectral regrowth). There are stringent regulatory controls on the amount of interference that a transmitter can spill to neighboring channels. In order to determine compliance with the allowable level of spurious emissions, two parameters need to be specified:

- Measurement channel bandwidth
- Allowable level of spurious emissions

24.3 In-band Spurious Measurement

The following procedure requires: Test Port Extension Cable and Attenuator (30 dB, 50 Watt, bi-directional, DC - 18 GHz, N(m) - N(f)).

Procedure:

1. Using the test port extension cable and 30 dB, 50 watt, (Bi-directional) attenuator, connect the **RF In** port to the appropriate transmit test port.
2. Press the **Frequency** main menu key, press **Center Freq**, and enter the center frequency.
3. Press the **Span** main menu key. Set the span wide enough to include the primary channel bandwidth and upper and lower channel bandwidths.
4. Press the **Amplitude** main menu key and then press the **Reference Level** submenu key to set the reference level to -20 dBm.
5. Press **RL Offset**. Enter 30, then select dB External Loss to compensate for loss in the attenuator.
6. Press the **Auto Atten** submenu key and set the attenuation to **On**.
7. Press the **BW** main menu key and use the **RBW** and **VBW** submenu keys to set the resolution bandwidth to 10 kHz and the video bandwidth to 300 Hz.
8. Press the **Marker** main menu key and press the Marker 123456 submenu key to select Marker 1. The underlined number indicates the active marker.
9. Press the **On/Off** submenu key and use the arrow keys, the keypad and the knob to move the marker over one of the spurs.
10. Compare the value of the marker to the specified allowable level of in-band/out-of-channel spurious emissions for the corresponding channel transmit frequency.
11. Repeat steps 9 and 10 for the remaining spurs. Either re-use Marker 1, or choose another marker.

24.4 Emission Mask

The emission mask is a segmented upper limit line that will display frequency range, peak power and frequency, relative power, and pass/fail status for each segment of the mask. The emission mask must have at least two segments.

-
1. Create or recall a multi-segment limit line or envelope to use as an emission mask. Refer to Section 33.2 for details on the Limit menu.
 2. Press the **Meas Set** menu key. Then press the **Masks and C/I** submenu key.
 3. In the Emission Mask submenu, press **On/Off** to turn Emission Mask On.
 4. The table at the bottom of the screen displays the pass/fail status of each Emission Mask segment.

Interference Analyzer

Interference Analysis is becoming a critical tool in analyzing the signal environment. Many wireless networks operate in complex signal environments, where three or four base station antennas may be located on the same tower. This can lead to interference problems - affecting system capacity and coverage.

The following chapters provides an overview of the S5700 series analyzer's Interference Analyzer measurement mode. The Interference Analyzer measurement option adds seven measurement capabilities to the spectrum analyzer to assist you in detecting, identifying, analyzing, and locating signal interference.

The following chapters provide an overview of these optional measurement applications:

- Spectrogram (Chapter 25)
- RSSI (Chapter 26)
- Signal Identification – SID (Chapter 27)
- Signal Strength (Chapter 28)
- Location Mapping (Chapter 29)
- Digital Persistence Spectrum (Chapter 30)
- Delta Spectrum (Chapter 31)

You can access software-enabled spectrum analysis applications by pressing the **Menu** button to the top- right of the display, tapping the **IA** icon, then selecting from the icons in the bottom pane.

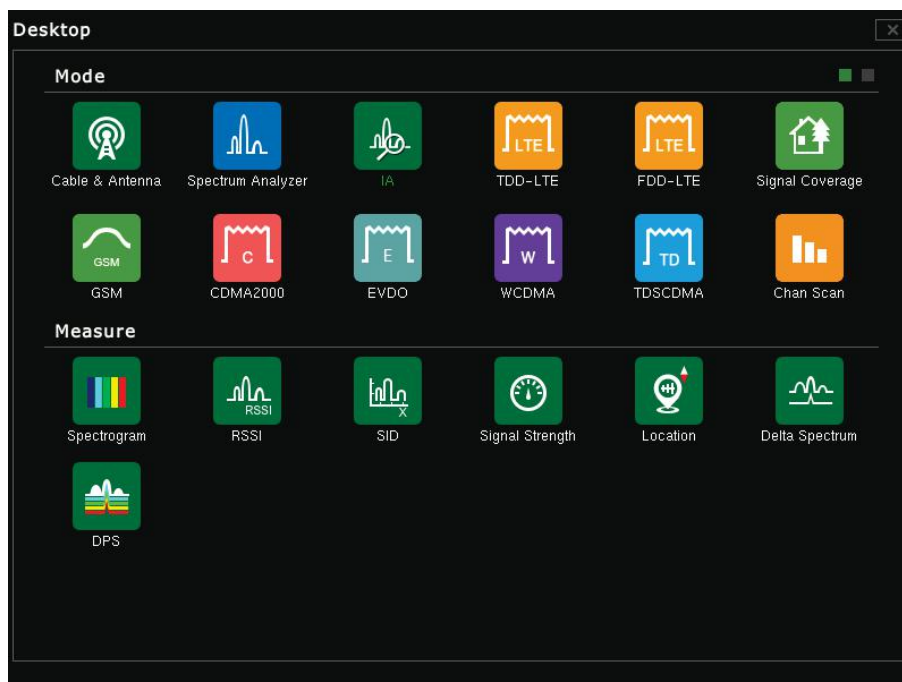

Chapter 25 Spectrogram

Introduction

The Spectrogram is a three-dimensional representation of frequency, time, and power that is useful in identifying intermittent interference. Frequency is defined along the horizontal axis, just as in a spectrum analyzer. Time is defined along the vertical axis. Color is used to represent the signal power levels.

NOTE: To perform a spectrogram measurement, place the instrument into Interference Analyzer mode and ensure that the instrument is set to the spectrogram measurement application. Select and attach an RF antenna that is suitable for the frequency band of interest that you will be monitoring.

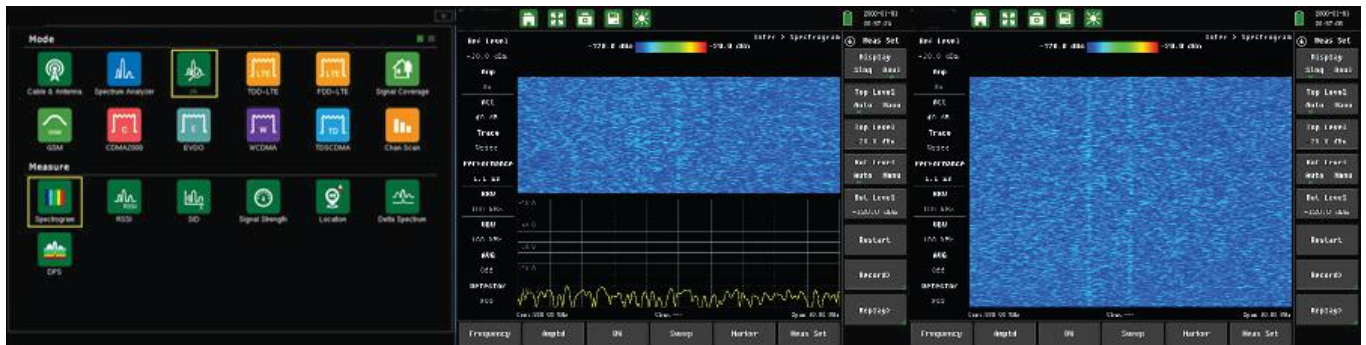

Fig.25.1 Locating the Spectrogram application (left) — Spectrogram in dual mode view (middle) — Spectrogram in single mode view (right)

Setting Up the Spectrogram Measurement

Procedure:

1. Set the **Frequency** range (or span) to be monitored.
2. Set the **Amplitude** reference level so that the largest signal to be displayed will be near the top of the display area of the screen. Generally, setting the top level to Auto mode should be sufficient.
 - a. The reference level can be determined by observing the color of the highest signal, and changing the reference level to place that value near the top – but not touching the top – of the display area.
3. Check the **Scale** setting. You will want to place the lowest expected signal near the bottom of the display; depending on the signal environment, you may want to change the scale setting from 10dB/division to 5dB/division. The Scale setting is in the Amplitude submenu.
4. Tap the **BW** main menu softkey and set RBW and VBW to **AUTO** mode.
 - a. For greater sensitivity, you can set RBW and VBW to manual and enter the desired settings, or turn ON the pre amp.
5. To change the time between sweeps, open the **Meas Set** menu and tap **Record**. Then tap **Time Interval** key and use the data keypad to set the time in μS . Entering the time interval causes the corresponding time span value to be automatically computed.
6. To set the total time span for a complete display, tap the **Time Span** submenu key and use the data keypad to set the time in seconds. Entering a time span value causes the corresponding sweep interval value to be automatically

computed.

7. The instrument can be set so that spectrogram plots are automatically saved when the display is full. Tap the **Record** submenu key, then tap the **Record On/Off** submenu key to the On position.
8. Once you have recorded a span of time, the file will be saved to internal memory.
 - a. Tap **Replay** and **Open File** to replay the recorded period. Tap **Pause** to replay once, or **Cont** to replay continuously.

Chapter 26 RSSI

Introduction

The Received Signal Strength Indicator (RSSI) is useful for observing signal strength at a particular signal frequency over time.

NOTE: To perform an RSSI measurement, place the instrument into Interference Analyzer mode and ensure that the instrument is set to the RSSI measurement application. Select and attach a RF antenna that is suitable for the frequency band of interest that you will be monitoring.



Fig.26.1 Locating the RSSI application (left) — RSSI mode view (right)

Setting Up the RSSI Measurement

Procedure:

1. Tap the **Time Interval** submenu key to set the time between adjacent measurement points. Typical time interval can be set from 1ms to 1 minute.

2. Tap the **Time Span** submenu key to set the overall time span for the RSSI measurement. The time span can be set from zero (to give manual control of the time span) to a maximum of seven days. When changing the time span in mid-measurement, tap the **Restart** submenu key to restart the measurement trace from the left edge (beginning) of the display.

NOTE: The Time Span only captures the most recent display - not the entire time of the time span. If necessary, use a longer time interval to extend the effective trace capture time.

3. Set the **scale** such that the measurement trace is near the top of the measurement display for more accurate measurement results. To set the scale, tap the Amplitude menu button located along the bottom of the display, then tap the Scale submenu button and then tap **Auto Scale**.

4. To store RSSI measurement data, tap the **Meas Set** submenu key and tap **Record On/Off** to turn on the data logging feature. The data is labeled “Log -”, followed by the time at which the data was stored.

5. Each measurement is stored as a separate display. Up to seven days of data can be saved. The unit saves data in the saved trace (image) directory; to recall it, select “Preview Image” in the **File Manager** (#1 datakey).

Chapter 27 Signal Identification (SID)

Introduction

The Signal ID (SID) measurement helps to quickly identify the different types of interfering signals. The results displayed include the Center Frequency and Bandwidth of the signal of interest as well as the type of signal (GSM, CDMA, etc.).

NOTE: To perform a Signal ID measurement, place the instrument into Interference Analyzer mode and ensure that the instrument is set to the Signal ID (SID) measurement application. Select and attach a RF antenna that is suitable for the frequency band of interest that you will be monitoring.



Fig.27.1 Locating the SID application (left) — SID mode view (right)

Setting Up the Single ID Measurement

Procedure:

1. For the most effective signal ID, you will want to set the Reference Level (**Ref Level**) such that the largest signal to be displayed will be near the top of the measurement display.
 - a. The reference level value can be determined by observing the peak of the highest level signal and changing the reference level to place that signal near the top of the display.
2. Check the **Scale** setting. You will want to place the lowest expected signal near the bottom of the display; depending on the signal environment, you may want to change the scale setting from 10dB/division to 5dB/division. The Scale setting is in the **Amplitude** submenu.
3. Tap the **BW** main menu softkey and set RBW and VBW to Auto mode ON. For greater sensitivity, you can set RBW and VBW to manual and enter the desired settings, or turn ON the pre amp.
4. The results of the signal ID measurement will be displayed in a table format located below the spectrum display of the signal environment.
 - a. Due to the fast sweeping nature of the instrument, you may want to use Single Sweep to better view the table of signal IDs listed once you have optimized your measurement parameters (such as frequency, reference level, and bandwidth).

Chapter 28 Signal Strength

Introduction

The Signal Strength meter is useful for tracking the source of an interfering signal, and in particular an emitter when using a directional antenna. This measurement is performed at a single frequency in zero span. The power at a frequency (in dBm or Watts) is displayed along with an audible indicator. When a directional antenna is connected, the frequency of the audible indicator increases as the measured signal strength increases.

NOTE: To perform a Signal Strength measurement, place the instrument into Interference Analyzer mode and ensure that the instrument is set to the Signal Strength measurement application. Select and attach a directional RF antenna that is suitable for the frequency band of interest that you will be monitoring.



Fig.28.1 Locating the Signal Strength application (left) — Signal Strength mode view (right)

Setting Up the Single Strength Measurement

Procedure:

1. Connect the appropriate directional antenna to the **RF In** port.
2. Set the scale by tapping the **Amplitude** menu, then tapping the **Scale** submenu key and **Auto Scale** submenu key to automatically scale the display range. Or, set the desired maximum and minimum values by tapping the Max Level and Min Level submenu keys.
3. To turn on the audio output, tap the **Voice On/Off** submenu key within the Measurement Setup (Meas Set) menu to the ON position.

Chapter 29 Interference Location Mapping

Introduction

The S5700 series analyzer's Interference Mapping feature enables users to quickly map the location of an interfering signal, with the use of a GPS-based directional antenna and a GeoEmbedded map loaded into the instrument.

A **GeoEmbedded map** can be created by using Measurement Center's "MapTile" software application. By importing map data from Google Maps, the Map Tile program creates **single-panel pan-and-zoom maps** that are compatible with the S5700 series Map files can be created with or without GPS information. See Appendix A - Creating GeoEmbedded Maps for a step-by-step guide to create a GeoEmbedded map.

After creating a map based on the geographic area of interest, **copy the map file** to a USB memory stick and insert the USB stick into the S5700 USB Type A connector. Copying the map file to the instrument's internal memory is recommended. See subsections 32.1.2 and 32.2.2 for a step-by-step guide on loading maps.

Once the GeoEmbedded map is loaded, and the GPS-based antenna is connected to the S5700 series via the instrument's USB port and N(f) RF connector, the instrument is ready to make a mapping measurement. With a valid GPS signal the instrument will identify the current location on the displayed map with a plus (+) sign.

Upon initiating and completing a mapping measurement, you will see a line originating from the measurement origin toward an interfering signal. You will need to save the measurement as a point of correlation in the interference mapping process. See sections 29.1 and 29.2 for a step-by-step guide on making interference mapping measurements.

Saved locations are displayed with a colored circle and corresponding line originating at the measurement origin toward the direction of the interfering signal. With two or more lines, you can determine where the lines intersect and accurately estimate the location of the interfering signal. See section 29.2 for a step-by-step guide on saving/loading interference mapping measurements.



Fig.29.1 Interference mapping measurement w/two vectors

Creating GeoEmbedded Maps

Saluki Instruments' Map Tools software is a PC-based software program that enables you to capture maps of any location and create GeoEmbedded map files (.jmap format) for use in the S5700 series.

For step-by-step instructions on how to create a GeoEmbedded map tile for Interference Analysis or Signal Coverage Mapping applications, please refer to **Appendix A - Creating GeoEmbedded Maps**.

29.1 Setting Up an Interference Location Mapping Measurement

NOTE: All GPS-based mapping requires that the GPS-based antenna have a clear view of the sky.

Loading the map file into the analyzer:

1. Copy the map covering the desired geographic area to a USB memory stick.
2. Insert USB memory stick into the USB Type A port.
3. Save map to the instrument's internal memory.

Setting up an interference mapping measurement:

1. Calibrate the direction-finding antenna.
 - a. **Connect** the direction-finding antenna. Plug the antenna into the instrument via USB port, and screw in the Type N(m) connector of the antenna to the instrument's N(f) RF connector.

- b. Open the **System Setup** menu by pressing the **System (#8)** data key. Tap the System Setup soft key located on the right edge of the display, and then tap the GPS soft key located on the left edge of the display.
 - c. Tap **GPS Enable ON** and then **GPS Test Start**.
 - d. Once the GPS Test has been started, hold the antenna so it is vertically polarized, and slowly rotate the antenna 360 degrees in a clockwise direction.
 - e. Performing two full rotations (720 degrees) is recommended for better antenna calibration.
2. Select **Interference Analysis** mode.
 3. After the antenna has been calibrated, set the instrument into Interference Analysis (IA) mode:
 - a. Tap the **Home** icon in the instrument's tool bar located at the top edge of the display (or by pressing the **Menu** button located to the right of the display). This will open the Measurement Mode Desktop.
 - b. Once the Measurement Mode Desktop is open, tap the interference analysis icon **IA**. This will open up the interference analysis measurement menu.
 4. Select the **Location** icon in interference analysis measurement menu. This will launch the interference location mapping function.
 5. To load (recall) the saved map from internal memory, first tap the **Map Manager** softkey.
 6. Select desired map and tap the **Load** softkey
 7. Depending on the orientation of your displayed map, you may want to zoom in or out and center your map. If so desired, choose among the following steps:
 - a. Tap the **Measurement** menu key located at the bottom edge of the display.
 - b. Tap the **Browser** softkey located at the right edge of the display.
 - c. Choose among the Zoom In, Zoom Out, Up, Down, Left, Right softkeys located at the right edge of the display to optimize you map view.
 8. Press the **Frequency** main menu key located at the bottom edge of the display. Tap Center Freq, located along the right edge of the display, to enter the desired center frequency. Set the Span.

29.2 Performing an Interference Location Mapping Measurement

The S5700 series feature two types of interference location mapping: Auto and Manual mode.

- Auto mode automatically detects the highest signal level after taking a 360-degree scan with a GPS-based antenna, and directs the measurement signal path from point of measurement origin to the highest level signal detected which typically corresponds with the interfering signal.
- Manual mode requires pointing the GPS antenna in the direction of the suspect interfering signal.

29.2.1 Auto mode mapping

Once you have loaded the Geo-Enabled Map for your area of interest and connected the GPS antenna to the USB Type A port and N(f) RF connector, you are ready to make an interference measurement. The following procedure will walk you through the steps necessary to make and save an **Auto Mode** interference mapping measurement. If you have not loaded the Geo-Enabled Map for your area of interest, please refer to Section 29.1.

1. Open the **FREQ** key and set the desired center frequency.
2. **Connect** the direction-finding antenna. Plug the antenna into the instrument via USB port, and screw in the Type N(m) connector of the antenna to the instrument's N(f) RF connector.
3. Press the **Meas Set** main menu key located along the bottom edge of the display, followed by the **Locate** softkey located along the right edge of the display.
4. Wait for the instrument to display the GPS location icon on the desired map display.
5. A blue plus (+) sign, indicating your current GPS-based location, should be present on the display map. If the blue plus sign is not present, press the **Locate** softkey.
6. Confirm that you have correctly calibrated your direction-finding antenna. (See Section 29.1.) Take four quick measurements in known North, East, West and South directions to confirm calibration.
7. Once correctly calibrated, press **Auto** on the **Max Direct** soft key. This method automates the process of finding the maximum signal strength. Press the **SCAN** soft key to select **ON**.
8. With the antenna held so it is vertically polarized, slowly rotate the antenna 360 degrees in a clockwise direction. The compass located on the measurement display will be filled in with dots, showing the amplitude of the signal strength measured in all directions. A red dot on the outer edge of the compass display shows the direction to the maximum signal strength.
 - a. The green dot represents the direction in which the antenna is aimed.
 - b. Once you fully rotate the antenna, the red dot will point towards maximum signal strength.
9. Press the **SAVE CURRENT POINT** softkey. This saves a vector in the direction of the maximum signal strength measured in the previous step. The instrument can save up to five signal vectors.
 - a. The aiming of the antenna isn't important for this step, since the maximum signal direction has been automatically determined.
10. Move to a different location, not in line with the previous measurement.
11. Press the **SCAN** soft key to set it **OFF**. This clears the measurements previously saved.
12. Press the **SCAN** soft key again to set it **ON**.
13. Again, with the antenna held so it is vertically polarized, slowly rotate the antenna 360 degrees. Press the **SAVE CURRENT POINT** softkey.
14. If the vectors cross, a round blue area on the screen will indicate the likely location of the emitter.
15. Move to a third location, not in line with either of the previous measurements.
16. Press the **SCAN** soft key to set it **OFF**. Press the **SCAN** soft key again to set it **ON**.
17. Again, with the antenna held so it is vertically polarized, slowly rotate the antenna 360 degrees. Press the **SAVE CURRENT POINT** softkey.
18. The round blue area on the screen shows the probable location of the emitter and may have been refined by having three crossing vectors.

29.2.2 Manual mode mapping

Once you have loaded the Geo-Enabled Map for your area of interest and connected the GPS antenna to the USB

Type A port and N(f) RF connector, you are ready to make an interference measurement. The following procedure will walk you through the steps necessary to make and save a **Manual Mode** interference mapping measurement. If you have not loaded the GeoEmbedded Map for your area of interest, please refer to Sections 29.1 and Appendix A of this manual.

1. Confirm that you have correctly set your center frequency for the Manual Mode Interference Mapping measurement. If the center frequency is not correct, press the **FREQ** key and edit it.
2. A blue plus sign indicating your current GPS-based location should be present on the display map. If the blue plus sign is not present, press the **Locate** soft key.
3. Confirm that you have correctly calibrated your direction-finding antenna. (See Section 29-1.) Take four quick measurements in known North, East, West & South directions to confirm calibration.
4. Once calibrated, select **Manu** on the **Max Direct** soft key. This method is traditional triangulation.
5. Press the **SCAN** soft key to turn select **ON**.
6. With the antenna held so it is vertically polarized, watch the amplitude display and aim the antenna in the direction in which the maximum signal strength is obtained.
7. Press the **SAVE CURRENT POINT** soft key. This saves a vector in the direction the antenna is pointed.
8. Move to a different location, not in line with the previous measurement.
9. Again, with the antenna held so it is vertically polarized, aim the antenna in the direction in which the maximum signal strength is obtained. Press the **SAVE CURRENT POINT** softkey.
10. This saves a second vector in the direction the antenna is pointed. If the vectors cross, there will be a round blue area on the screen that shows the probable location of the emitter.
11. Move to a third location, not in line with either of the previous measurements.
12. Aim the antenna in the direction in which the maximum signal strength is obtained.
13. Press the **SAVE CURRENT POINT** softkey.
14. The round blue area on the screen shows the probable location of the emitter and may have been refined based on the additional vector.
15. Up to five vectors can be saved.

Saving the interference mapping measurement to memory:

After you have finished your Auto or Manual interference mapping measurement showing the location of an interfering signal (2-3 signal vectors that intersect), you will want to save your mapping measurement as proof. The instrument offers two save options in interference mapping:

1. Save image
 - a. Press the **Scrnshot** (#4) key to take a screenshot of the interference map. The image is automatically saved by time and date stamp (e.g., “snap_2015_03_01”).
 - b. If you prefer to use a descriptive format to label your measurement, press the **File** (#1) key to open the File Manager, enabling you to rename the image and transfer it from local storage to a connected USB drive.
2. Save KML Points

a. Press the Save button to open the File Save screen. Tap Measurement and select .kml, then name and save the file. The .kml file can be opened and viewed on a PC with Google Earth.

See Chapter 34 - File Management for more information on naming and saving images.

Chapter 30 Digital Persistence Spectrum

Introduction

The Digital Persistence Spectrum (DPS) mode is ideal for detecting transient signals that frequently slip past conventional spectrum analyzers. DPS provides a snapshot of the entire frequency spectrum, as opposed to a swept line trace that only shows one power level for each frequency point.

The DPS measurement mode provides an intuitive DPS Mask covering a 20MHz span that employs FFT processing of several thousand spectrums/second, translating the data into colors to denote the frequency of occurrence within the mask, easily capturing pulsed, frequency hopping and other random transient signals with 100% Probability of Intercept (POI).

NOTE: To perform DPS measurement, place the instrument into Interference Analyzer mode and ensure that the instrument is set to the Digital Persistence Spectrum measurement application. Attach an RF antenna that is suitable for the frequency band of interest that you will be monitoring.



Fig.30.1 Locating the DPS application (left) — DPS mode view (right)

Setting Up the DPS Measurement

Procedure:

1. Press the **Menu** key located on the front panel. Tap Interference Analysis (**IA**) in the measurement mode desktop, followed by **DPS** in the measurement application menu.
2. Set the **Frequency** range (or span) to be monitored.
3. Set the **Amplitude** level so that the largest signal to be displayed will be near the top of the display area of the screen. Generally, setting the top level to Auto mode should be sufficient.
 - a. The reference level can be determined by observing the color of the highest signal, and changing the reference level to place that value near the top - but not touching the top - of the display area.
4. With Amplitude menu open, tap the **Attenuation** submenu. Toggle the attenuation setting to Auto.

NOTE: The RBW in DSP is fixed at 300kHz for optimal measurement accuracy.

NOTE: The Refresh cycle represents how often the display is updated.

-
5. To activate a marker, tap the **Marker** main menu key, and then tap **Select Marker** to activate a single marker from M1-M6. (Up to six markers can be turned on, but only one marker can be active.)
 6. To move the active marker, tap **Normal** (or Delta) so that the normal marker key is highlighted, and then tap the **Move** key to toggle the marker movement action from X-direction (horizontal) to the Y- direction (vertical) and vice-versa. Markers can also be moved with the arrow keys or rotary knob.

Chapter 31 Delta Spectrum

Introduction

The Delta Spectrum measurement allows the user to directly compare the delta spectrum waveform to a reference spectrum, which the user can base upon any trace saved from an existing measurement. This is a useful function for tracking down the source of an interfering signal in real-time.

NOTE: To perform a Delta Spectrum measurement, place the instrument into Interference Analyzer mode and ensure that the instrument is set to the Delta Spectrum measurement application. Select and attach an appropriate antenna that is suitable for the frequency band of interest that you will be monitoring.



Fig.31.1 Locating the Delta Spectrum application (left) — Delta Spectrum mode view (right)

Setting Up the Delta Spectrum Measurement

Procedure:

1. Tap the **Frequency** menu softkey. Set the frequency range (or span) to be monitored.
2. Set the **Amplitude** level so that the largest signal to be displayed will be near the top of the display area of the screen. Generally, setting the top level to Auto mode should be sufficient.
 - a. The reference level can be determined by observing the color of the highest signal, and changing the reference level to place that value near the top - but not touching the top - of the display area.
3. With Amplitude menu open, tap the **Attenuation** submenu. Toggle the attenuation setting to **Auto**.
4. Tap the **Meas Set** menu softkey. Tap **Restart**. The current sweep will be re-traced and set as the reference standard, over which the delta spectrum waveform appears.

Chapter 32 Signal Coverage Mapping

Introduction

The Signal Coverage Mapping option allows users to map RSSI and ACPR measurements, and is suitable for both indoor and outdoor mapping.

Saluki Map Tools software enables users to create map files with or without GPS information. The files have either a **.jmap** (outdoor / GeoEmbedded) or **.mai** (indoor / non-GeoEmbedded) extension, and are fully compatible with S5700 series analyzer.

This chapter provides an overview of the Indoor & Outdoor Signal Coverage Mapping measurement modes.

Signal Coverage measurements include:

- Indoor SS (Section 32.1)
- Drive / Outdoor Test SS (Section 32.2)

To make a Signal Coverage measurement, press the **Menu** key and tap the **Signal Coverage mode** icon. Then select the desired signal coverage measurement icon (Indoor SS, Drive Test SS, Netclean Test, TDD-LTE Outdoor or FDD-LTE Outdoor) to activate the measurement.

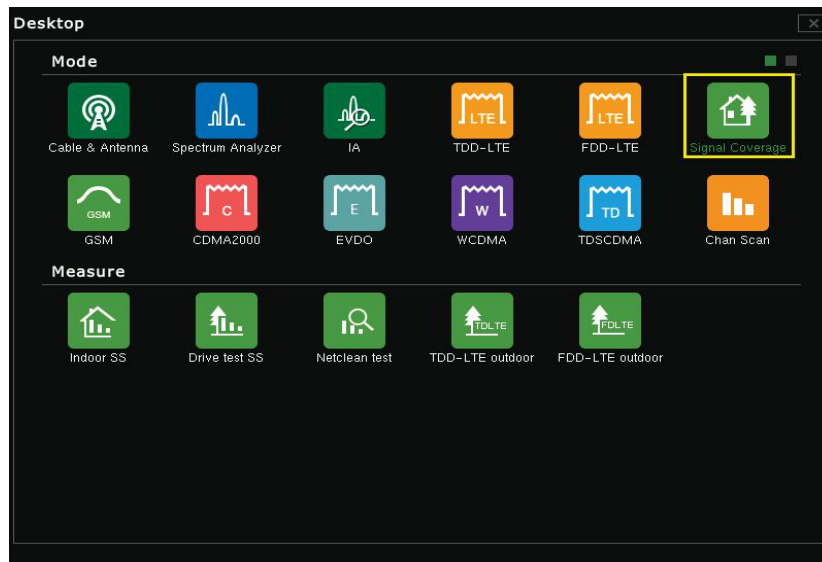

Fig.32.1 Locating the Signal Coverage Mapping application

32.1 Indoor SS

If there is no GPS signal present, the S5700 series uses a “start-walk-stop” approach to record RSSI and ACPR levels. The instrument provides in-building coverage mapping by overlaying data directly onto the downloaded map. Data is captured at user-defined intervals or map locations.

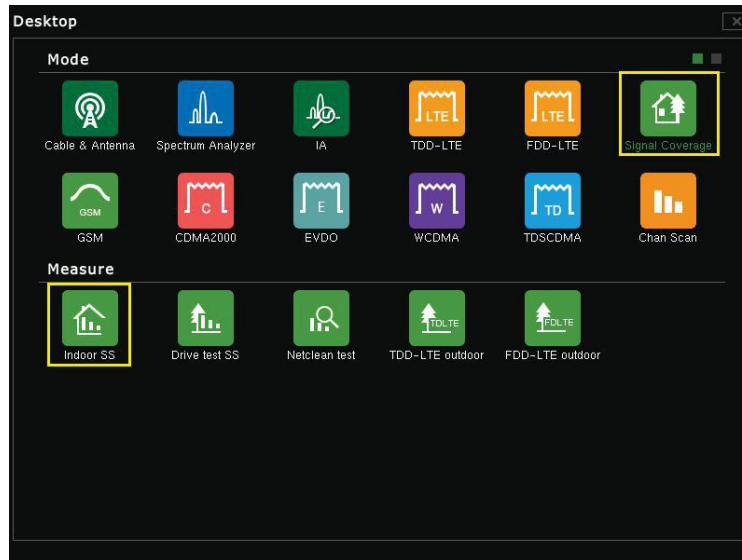

Fig.32.2 Locating the Indoor SS application

32.1.1 Creating a non-GeoEmbedded map file for indoor SS measurements

When documenting signal levels on location, you may need to perform an indoor signal coverage survey. The S5700 series can be upgraded with option Signal Coverage Mapping. This option supports both indoor and outdoor mapping applications.

To create a non-GeoEmbedded map file (.mai format) for use in indoor mapping, you will need to use the Saluki Indoor Map Converter software included on CD with the instrument.

Please see Appendix B for step-by-step instructions on this process, then continue from this point.

Note: A USB flash drive is required to transfer maps to the instrument.

32.1.2 Copying the non-GeoEmbedded map file onto the instrument's internal memory

Once you have created, labeled, and saved a non-GeoEmbedded Map using the Indoor Map Converter software, you can load the map onto a USB memory stick and copy it into the internal memory.

1. Select the **Signal Coverage** measurement mode, and then select the **Indoor SS** measurement application. Insert the USB memory stick containing your map file into the USB slot located on the top panel of the instrument.
2. Select **Building Manager** from the File Manager submenu, and toggle the **Location** to USB.
3. Select the desired map from the pop-up File Manager box located in the middle of the display, then press **Copy to Local**.
4. When the map has been successfully copied to the instrument's internal memory, the map will appear in the Building Manager dialog box. Press **Esc** and return to Building Manager.
5. Select the desired outdoor map from the File Manager box in the middle of the display. **Press Load**.

32.1.3 Performing an indoor SS mapping measurement





Prior to conducting an indoor signal mapping survey, the analyzer itself must be properly configured to make an accurate measurement based on the signal of interest. This setup pertains to the configuration of the spectrum analyzer main control functions, e.g. frequency of interest, span, reference level, bandwidth and detector settings. Knowledge of your environment and anticipated signal strength in addition to potential presence of interfering signals should be used in determining the optimal spectrum analyzer setting prior to performing the Indoor Signal Coverage Survey.

1. Open the **Meas Set** menu. Ensure that **Measure** is set to **Stop**.
2. Open the **Frequency** menu and enter the Center Frequency to be measured.
3. Open the **Amptd** menu.
 - a. Adjust **Ref Level**. Input signals are referenced to the top line of the display (graticule), and thus is known as the reference level. Depending on the amount of power anticipated in the signal environment to be measured, the reference level should be adjusted accordingly. For best measurement results, the highest-level signal should be positioned near the top of the display, second to third graticule down.
 - b. Adjust **Attenuator** and **Pre-Amplifier**. In order to display the proper signal level to the spectrum analyzer without overdriving the input circuitry of the spectrum analyzer, you may have to adjust the signal attenuation level. Generally, the attenuator is auto-coupled to the reference level. In general, signals below -40 dBm can benefit by using the pre-amplifier, while signals above -30 dBm should use additional attenuation.
4. Open the **BW** menu.
 - a. Resolution Bandwidth (**RBW**) is the minimum bandwidth over which the spectrum analyzer can separate two signals for viewing. Decreasing the RBW enables viewing of closely spaced signals and also limits noise distortion, resulting in improved displayed average noise level (DANL) but slower sweep speed. 300kHz is recommended for most signal coverage measurements. Generally, the sweep speed is auto-coupled to the RBW.
 - b. Video Bandwidth (**VBW**) is used for averaging and filtering noise. This is particularly useful in detecting low-level signals in the presence of noise.
5. Press the **Trace (#5)** key and open the **Detector** submenu. Various detection methods for coverage measurements are available, including Positive Peak, Negative Peak, RMS, and Sample detection.
6. **Filtering** should be considered if measuring signals in the presence of potential signal interference. Filters can be added to the input of the analyzer to discriminate between desired and undesired signals, or avoid corruption of the measurement due to adjacent high-level signals.

Once the spectrum analyzer has been configured (this can be done in Signal Coverage measurement mode as well), you will need to set the parameters for the drive test signal coverage mapping application. These settings include measurement threshold RSSI and measurement mode settings.

7. Measurement Threshold RSSI settings enable the user to edit the RSSI thresholds for the dBm values so

that all values on the indoor signal coverage map are color coded according to the expected signal levels. The threshold RSSI values provide the user with easy visibility of the power level. In the coverage mapping menu press the Meas Set main menu tab along the bottom of the display, then select Threshold in the submenu along the right hand edge of the display to check and/or set your desired RSSI threshold dBm level. Generally the RSSI threshold levels should be spaced approximately 10 dBm apart, from one level to the next level.

	Excellent
	Very Good
	Good
	Fair Poor
	Extremely Poor

8. You can set the data collection method to either Time- or Distance-based intervals. In the outdoor mapping menu, press **Meas Set**, then select the **Setup** submenu along the right-hand edge of the display to set your desired measurement data collection mode: **Time** or **Free** (Distance).

a. **Time:** the instrument will interpolate the data points between the starting and ending position in a straight line.

b. **Free** (Distance): the user must establish a starting data point by opening the Marker menu and pressing Sign to establish the starting point (the blue cross-hair symbol will change to a red cross-hair), then pressing Sign again to indicate the ending point. The signal coverage mapping will automatically plot the data points (on line).

Collecting Mapping Data

After successfully creating and loading your indoor map file, setting the spectrum analyzer and indoor signal coverage mapping parameters, you are ready to collect indoor signal coverage mapping data.

1. Press the **Meas Set** menu tab along the bottom of the display and select **Start**.
2. Open the **Marker** menu by pressing the Marker tab along the bottom of the display.
3. Press **Move Mark** located along the right edge of the display, then toggle between **X** and **Y** Direction to move the blue cross-hair marker to establish your starting point on your indoor map.
4. Measurements can be made point-to-point by making a single measurement, moving to the next location in a start-measure-walk-measure-stop approach.
5. To begin a measurement, position the blue cross-hair to your starting position by using the **X-Y** and **Move Mark** keys. Once you have set the blue cross-hair to your current location on the indoor map, select the **Sign** tab along the right edge of the display. This will change the blue cross-hair symbol to red, indicating that it is the beginning point of the measurement.
6. To complete the point-to-point measurement, select the **Sign** tab again. A color-coded data point will appear on the map that corresponds to the RSSI signal level at that point (the blue cross hair will reappear, indicating that the data point has been plotted on the indoor map). Move the blue cross- hair to the next measurement point using the **X-Y** and **Move Mark** keys and repeat.

Indoor mapping measurements can also be made in a continuous line, either X or Y direction.

7. To begin a measurement, position the blue cross-hair to your starting position by using the **X-Y** and **Move Mark** keys. Then, select the **Sign** tab along the right edge of the display. This will change the blue cross-hair symbol to red, indicating that it is the beginning point of the measurement.

8. To complete the continuous line measurement, walk to the last point in your straight line, then select the **Sign** tab again. A color-coded data line will appear on the map that corresponds to the RSSI signal level from point A to point B (the blue cross hair will reappear, indicating that the data point has been plotted on the indoor map). However, within the continuous line, the colors may change, reflecting the differences in RSSI levels. Move the blue cross-hair to the next point using **X-Y** and **Move Mark**, and repeat.

9. Once all the indoor signal coverage data points have been plotted, press the **Meas Set** menu tab along the bottom of the display, then press **Stop** to complete the survey.



Fig.32.3 Indoor SS measurement interface

32.1.4 Saving the indoor SS mapping measurement

1. Press the **Save** button on the instrument's front panel. This opens the Save File function.
2. Use the pop-up keyboard to label the measurement. For more details, see Section 34.2.
 - a. To save as a measurement, tap **Measurement** after labeling the measurement and tap the **Save** key located along the right side of the display.
 - b. To save as an image, tap **Image** after labeling the measurement and tap the **Save** key located along the right side of the display.

32.1.5 Loading the indoor SS mapping measurement

1. Press the **File (#1)** key on the instrument's data keypad. This opens the File Management function.
2. Highlight the mapping measurement you want to view by tapping the measurement file listed.

- a. If you want to view the file as a measurement, tap **Measurement** and then tap **Read**.
 - b. If you want to view the file as an image, tap **Image** and then tap **Preview**.
3. If you want to export the image or measurement to a USB memory stick for insertion into an email or report, insert your USB device into the instrument's top connector panel and tap **Export to USB Disk**.
 4. Once the Indoor SS map is loaded onto the USB device, you can transfer to your PC by copying the measurement file to your PC's internal storage.

32.2 Outdoor SS

When there is a valid GPS signal present (confirmed by installing a GPS antenna to the instrument), the S5700 series can monitor and measure the RSSI and ACPR levels automatically. The instrument logs data automatically based on time or distance interval. If no map is available, you can also save the data to a KML file and lay the information over a Google Earth map. See subsection 32.2.6 for more on this feature.

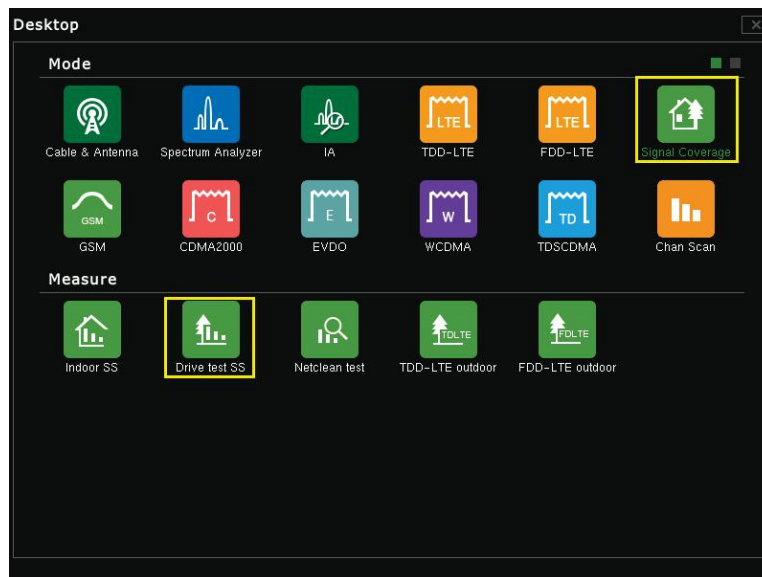

Fig.32.4 Locating the Outdoor SS application

32.2.1 Creating a GeoEmbedded map file for outdoor SS measurements

When documenting signal levels on location, you may need to perform an outdoor signal coverage survey. The S5700 series analyzer can be upgraded with option Signal Coverage Mapping. This option supports both indoor and outdoor mapping applications.

To create a GeoEmbedded map file (.jmap) for use in outdoor mapping, you will need to use the Map Tools software included on CD with the instrument.

Please see Appendix A for step-by-step instructions on this process, then continue from this point.

NOTE: A USB flash drive is required to transfer maps to the instrument.

32.2.2 Copying the GeoEmbedded map file onto the instrument's internal memory

Once you have created, labeled, and saved a GeoEmbedded Map using the Indoor Map Converter software, you

can load the map onto a USB memory stick and copy it into the internal memory.

1. Select the **Signal Coverage** measurement mode, and then select the **Drive Test SS** measurement application. Insert the USB memory stick containing your map file into the USB slot located on the top panel of the instrument.

2. Select **Map Manager** from the File Manager submenu, and toggle the **Location to USB**.

3. Select the desired map from the pop-up File Manager box located in the middle of the display, then press **Copy to Local**.

4. When the map has been successfully copied to the instrument's internal memory, the map will appear in the Building Manager dialog box. Press **Esc** and return to Building Manager.

5. Select the desired outdoor map from the **File Manager** box in the middle of the display. **Press Load**.

32.2.3 Performing an outdoor SS mapping measurement

Prior to conducting an indoor signal mapping survey, the analyzer itself must be properly configured to make an accurate measurement based on the signal of interest. This setup pertains to the configuration of the spectrum analyzer main control functions, e.g. frequency of interest, span, reference level, bandwidth and detector settings. Knowledge of your environment and anticipated signal strength in addition to potential presence of interfering signals should be used in determining the optimal spectrum analyzer setting prior to performing the Indoor Signal Coverage Survey.

1. Open the **Meas Set** menu. Ensure that **Measure** is set to **Stop**.

2. Open the **Frequency** menu and enter the Center Frequency to be measured.

3. Open the **Amptd** menu.

- a. Adjust **Ref Level**. Input signals are referenced to the top line of the display (graticule), and thus is known as the reference level. Depending on the amount of power anticipated in the signal environment to be measured, the reference level should be adjusted accordingly. For best measurement results, the highest-level signal should be positioned near the top of the display, second to third graticule down.

- b. Adjust **Attenuator** and **Pre-Amplifier**. In order to display the proper signal level to the spectrum analyzer without overdriving the input circuitry of the spectrum analyzer, you may have to adjust the signal attenuation level. Generally, the attenuator is auto-coupled to the reference level. In general, signals below -40 dBm can benefit by using the pre-amplifier, while signals above -30 dBm should use additional attenuation.

4. Open the **BW** menu.

- a. Resolution Bandwidth (**RBW**) is the minimum bandwidth over which the spectrum analyzer can separate two signals for viewing. Decreasing the RBW enables viewing of closely spaced signals and also limits noise distortion, resulting in improved displayed average noise level (DANL) but slower sweep speed. 300kHz is recommended for most signal coverage measurements. Generally, the sweep speed is auto-coupled to the RBW.





b. Video Bandwidth (**VBW**) is used for averaging and filtering noise. This is particularly useful in detecting low-level signals in the presence of noise.

5. Press the **Trace** (#5) key and open the **Detector** submenu. Various detection methods for coverage measurements are available, including Positive Peak, Negative Peak, RMS, and Sample detection.

6. **Filtering** should be considered if measuring signals in the presence of potential signal interference. Filters can be added to the input of the analyzer to discriminate between desired and undesired signals, or avoid corruption of the measurement due to adjacent high-level signals.

Once the spectrum analyzer has been configured (this can be done in Signal Coverage measurement mode as well), you will need to set the parameters for the drive test signal coverage mapping application. These settings include measurement threshold RSSI and measurement mode settings.

7. Measurement **Threshold RSSI** settings enable the user to edit the RSSI thresholds for the dBm values so that all values on the indoor signal coverage map are color coded according to the expected signal levels. The threshold RSSI values provide the user with easy visibility of the power level. Press the **Menu** button and open the **Signal Coverage** measurement mode, then **Outdoor SS**. Open the **Meas Set** submenu. Select **Threshold** in the submenu along the right hand edge of the display to check and/or set your desired RSSI threshold dBm level. Generally the RSSI threshold levels should be spaced approximately 10 dBm apart, from one level to the next level.

	Excellent
	Very Good
	Good
	Fair Poor
	Extremely Poor

8. You can set the data collection method to either Time- or Distance-based intervals. In the outdoor mapping menu, press **Meas Set**, then select the **Setup** submenu along the right-hand edge of the display to set your desired measurement data collection mode: **Time** or **Free** (Distance).

c. **Time**: the instrument will interpolate the data points between the starting and ending position in a straight line.

d. **Free** (Distance): the user must establish a starting data point by opening the Marker menu and pressing Sign to establish the starting point (the blue cross-hair symbol will change to a red cross-hair), then pressing Sign again to indicate the ending point. The signal coverage mapping will automatically plot the data points (on line).

9. After successfully creating and loading your map file, as well as setting the spectrum analyzer and outdoor signal coverage mapping parameters, you are ready to begin collecting outdoor signal coverage mapping data.

Collecting Mapping Data

To begin Drive Test Signal Coverage Mapping:

1. Press the **Meas Set** menu tab along the bottom of the display and select **Start**.
2. With the Meas Set submenu still open, press **Auto** (this will establish your current GPS location with a blue cross-hair symbol on the display).
3. Once all the outdoor drive test signal coverage data points have been plotted, press the **Meas Set** menu tab along the bottom of the display, then press **Stop** to complete the survey.

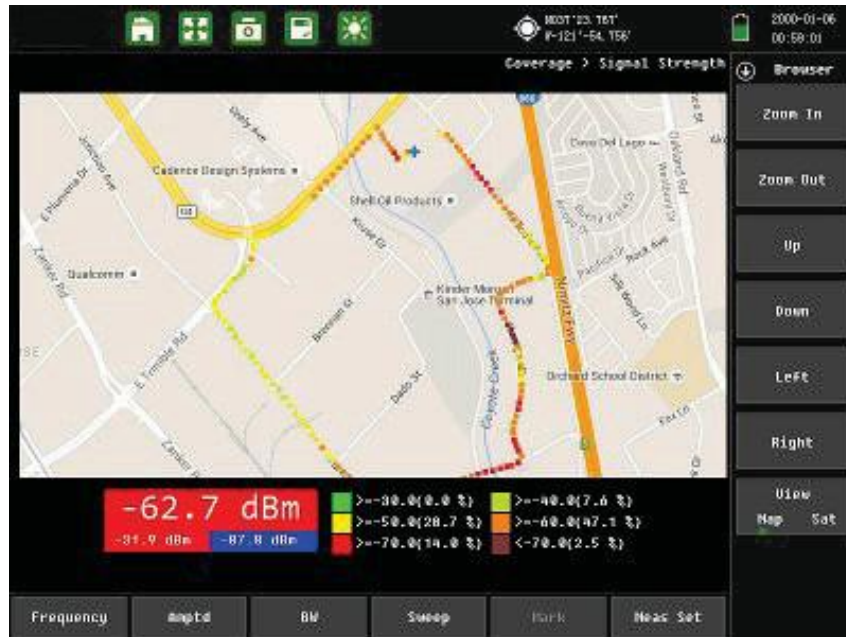

Fig.32.5 Outdoor SS measurement interface

32.2.4 Saving the outdoor SS mapping measurement

1. Press the **Save** button on the instruments front panel. This opens the Save File function.
2. Use the pop-up keyboard to label the measurement. For more details, see Section 34.2.
 - a. To save as a measurement, tap **Measurement** after labeling the measurement and tap the **Save** key located along the right side of the display.
 - b. To save as an image, tap **Image** after labeling the measurement and tap the **Save** key located along the right side of the display.

32.2.5 Loading the outdoor SS mapping measurement

1. Press the **File** (#1) key on the instrument's data keypad. This opens the File Management function.
2. Highlight the mapping measurement you want to view by tapping the measurement file listed.
 - a. If you want to view the file as a measurement, tap **Measurement** and then tap **Read**.
 - b. If you want to view the file as an image, tap **Image** and then tap **Preview**.
3. If you want to export the image or measurement to a USB memory stick for insertion into an email or report, insert your USB device into the instrument's top connector panel and tap **Export to USB Disk**.
4. Once the Indoor SS map is loaded onto the USB device, you can transfer to your PC by copying the

measurement file to your PC's internal storage.

32.2.6 Performing a drive test without a map

There may be times when you wish to perform a drive test at a particular location, but cannot readily access an online mapping service such as Google Maps or Open Street. In this scenario, you can perform the drive test and save the mapping data alone, allowing you to lay it over a map acquired from Google Earth when available.

Procedure:

1. First, in order to open .kml files on your PC, you will need to download the Google Earth software from <http://google.com/earth/>. There is no installation required. Once the software has been downloaded, .kml files will automatically associate with Google Earth.
2. Ensure that a USB storage device is inserted into the USB port on the instrument's top panel.
3. Enter the **Drive Test SS** measurement mode and perform an outdoor signal coverage survey, as described in subsection 32.2.3.
4. Once you have completed the drive test, press the **Save** button to the right of the display.
5. Next to **File Type**, tap the **Measurement** softkey. A choice of associated file extensions will appear. Tap **.kml**.
6. Next to **Location**, tap **USB**.
7. Proceed to name and save the file, as described in subsection 32.2.4.
 - a. After saving, exit the Save screen and press the **File (#1)** datakey to open the **File Manager** screen. Tap **USB** to ensure that the .kml file saved correctly. If not, repeat from step 4.
8. Once the file has saved, remove the USB storage device and connect it to your PC.
9. Locate the .kml file on the USB device. Double-click to open the file in Google Earth.
10. As Google Earth launches, it will automatically zoom in on the location of your previous drive test and display the signal coverage test data on top of the map. You may pan, zoom, and otherwise navigate the image as desired.
 - a. Under the **Places** tab to the left of the viewing pane, the .kml file will appear as a blue hyperlink. Click it to view additional information about the measurement. Double-click the gray text beneath the hyperlink to return the viewing pane to your drive test location.
 - b. You can also view each dot, representing a sweep,



Fig.32.6 Outdoor coverage survey in .KML format, displayed in Google Earth

Chapter 33 Markers and Limit Lines

Introduction

When you have successfully completed a measurement and wish to analyze the results, several options are open to you. Activating markers or marker functions will provide you with a readout of the RF measurement at a specific point, giving you the amplitude reading at a given frequency. Setting limit lines enables a quick “pass/fail” analysis of the reflection performance.

33.1 Setting a Marker

A marker is a tool for extracting results from traces (or from trace memory). Among other functions, markers can be used to measure the amplitude of a spike on a cable analyzer measurement, or to indicate certain places on the sweep. Using markers and delta markers, you can make many measurements that deal with the change in power with frequency or time.

To set one or more independent markers on the measurement display, tap the **Marker** main menu softkey. Ensure that the Marker submenu is open and follow the steps below.

In the menu on the right-hand side of the screen, you can toggle Marker 1 and Marker 2 On/Off. Whichever marker you last selected will be the **active marker**, indicated by a small green square (■) next to its name in the Marker menu. The active marker can be freely moved along the measurement trace with the arrow keys or rotary knob. You may also use the data keypad to enter a numerical position in distance units; enter the value, then tap the desired unit (km, m, cm, or mm) in the submenu that appears to the right.

NOTE: Although multiple markers (up to eight) can be turned on, only one can be the current active marker (meaning that this marker can be moved, the mode changed, etc). All other markers, although on, are frozen in the spot they were placed at the time they were activated.

Tap **Marker Table** to toggle it On/Off; this setting displays a list of currently placed markers and their positions underneath the measurement display. Select **Large Display** to show only the active marker’s location in larger type.

Tap **All Markers OFF** to disable all placed markers. Markers turned off and back on will retain their position. Open the More Markers submenu to set additional markers. You can set up to eight markers at a time.

Selecting, Activating and Placing a Delta Marker

When the Delta marker is set, the position set by the Delta marker becomes the reference position of the corresponding Normal marker, and the marker’s X and Y values display the difference compared with the Delta marker. The reference position will be fixed.

1. In the **Marker** submenu, toggle the marker of your choice **On** (making it the active marker).
2. Toggle the **Delta** function **On** to activate the delta marker corresponding to the active normal marker. Delta markers are indicated by a Δ icon (e.g., Marker 1’s delta is $\Delta 1$). In the top-right of the display, the difference between delta markers’ and their corresponding normal markers’ positions will appear.
3. To add additional delta markers, repeat steps 1 and 2.

Using Marker Auto Search

In the Marker main menu, tap **Search** to open the Search submenu. These functions can be used to automatically guide the active marker to the highest or lowest point of the measurement (**Marker to MAX/MIN**), to particular peaks and valleys (**Marker to Peak/Valley**), or to fault points (**Auto Search Fault Point**).

33.2 Using Limit Lines

Limit lines can be used for setting pass/fail criteria, or simply for the user's visual reference. Limit failures are reported whenever a signal is above the upper limit line or below the lower limit line. Two types of limit lines can be specified: lower limit lines and upper limit lines.

A limit line may consist of a single segment or as many as 40 segments. These limit segments are retained regardless of the current frequency span of the instrument, which allows the configuring of specific limit envelopes at various frequencies of interest – without having to re-configure them each time the frequency is changed.

An upper (MAX) limit will automatically mark red any regions of the measurement that are higher than specified, and will display a FAIL sign. A lower (MIN) limit will do the same for any regions lower than specified. To set one or more limit lines on the measurement display, press the **Limit (#6)** datakey or tap the Limit menu key along the bottom of the display.

Limit function may differ depending on the active measurement mode. For instance, power meter limit lines appear as borders of a green zone on the meter, indicating the region of “pass” (within-limit) values. The following instructions apply chiefly to limit function within the Cable Analyzer measurement mode.

Setting a Single Limit Line

1. First, in the Limit menu, toggle **Limit Test** to ON to display the limit line in red.
2. Tap the **Single Limit** softkey to open a submenu. Here you can select MAX to set an upper limit, MIN to set a lower limit, or **OFF** to cancel and return.
3. Tap **Single Value** to set the limit line's position. Use the arrow keys, rotary knob, or data keypad to adjust, then press Enter to confirm.

Setting Multiple Limit Line

1. In the Limit menu, tap **Single Limit** and select OFF.
2. Tap **Edit Limit**. The display will shrink to accommodate a preview of the current measurement and a limit table.
3. Tap **Add** to add a new limit line to the table. From left to right, you can tap each field to adjust it using the arrow keys, rotary knob, or data keypad. Tap a field once to outline it, and again to edit.
 - a. **Type:** Choose OFF to turn off the limit, MIN to set an upper limit, or MAX to set a lower limit.
 - b. **Begin Distance:** Set the distance at which the limit will begin testing for pass/fail. Enter a value, then select the intended distance unit: km, m, cm, or mm.

-
- c. **End Distance:** Set the distance at which the limit will stop testing for pass/fail.
 - d. **Begin Amplitude:** Set the amplitude (how high/low) for the start of the limit line. You can use this feature to set a limit that rises or falls at various points through the measurement.
 - e. **End Amplitude:** Set the amplitude (how high/low) for the end of the limit line.
4. Tap anywhere on an unwanted limit line in the table and tap **Delete** to erase it.
 5. You may set up to 20 limit lines. When you are finished, tap **Return** to go back.

Limit Alarm

If active, the Limit Alarm feature notifies the user with a series of audible beeps if the current measurement exceeds a placed limit line. Simply tap the Limit Alarm softkey to toggle it ON or OFF.

Part 3

System

Chapter 34 File Management

Introduction

This chapter provides an overview of the S5700 series analyzer’s file management features, and describes the File Manager (shown below) and File Save menus.

The instrument can automatically store parameters. Once the instrument is powered on, it will automatically recover the pre-shutdown state. This simplifies the setup process. The user can also set the instrument state by saving configuration files that contain the instrument’s measurement mode, frequency, distance, markers, and other parameters and calibration data at a particular point in time.

Stored measurement files can be used for managing measurement results. Users can load previous measurements into the instrument’s internal memory to compare or calculate data; then import multiple results into the PC management software for detailed analyses, data management, and report generation.

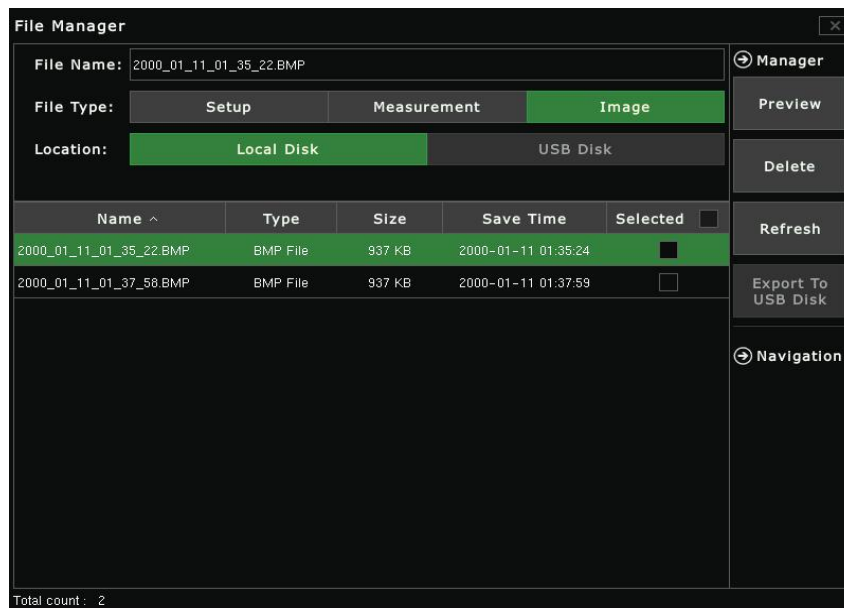

Fig.34.1 File manager

34.1 Overview

Remember the following tips when viewing Chapter34, “File Management”:

- Saved measurements also contain setup information.
- Read measurements may change the current instrument settings (which will not be saved) in order to display the read measurement.
- Calibration information is read with setup files, but not recalled with measurement files.
- Rename saved files under the file management (**File > File Manager**) menu.
- Sort files by tapping the column headings.
- Quickly move up or down long lists by using the buttons under the **Navigation** submenu.

- Determine where files are saved (either Internal Memory or USB) with the Set Location button in the **File Save** submenu (Save > Location).
- Use the **Right** arrow key to visit a highlighted folder, and the Left arrow key to exit the folder.
- Press **Esc** to return to the previous screen.

34.2 Saving Files

34.2.1 Naming a File

Access the **File Save** screen by pressing the  icon at the top of the display, or the **Save** key on the top-right of the instrument (underneath **Menu**). From this screen, you may save your current system settings, traces, or screenshots. Once you have successfully determined the filename, type, and location, press the Save softkey on the right side of the File Save menu to finish.

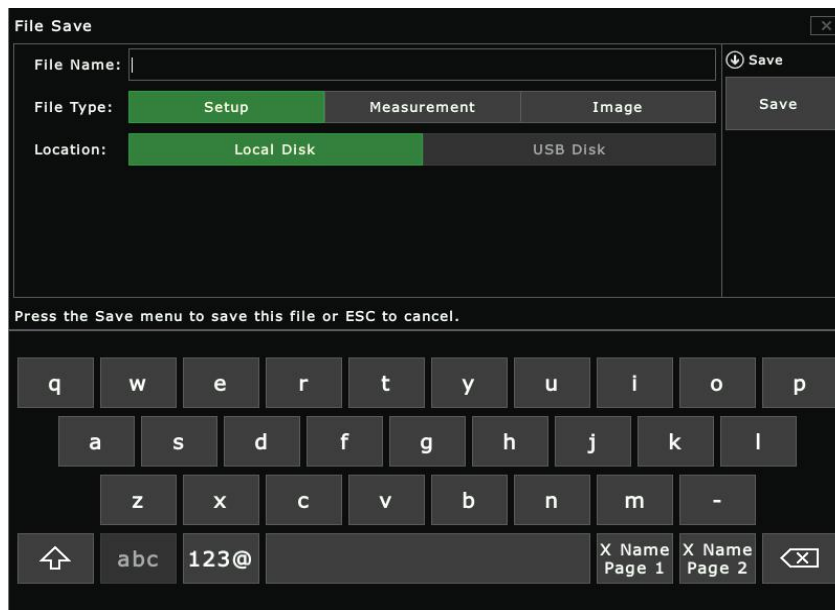

Fig.34.2 File save

Entering a filename

Tap the empty field next to File Name. A white cursor will flash, indicating you are ready to type.

Use the keypad on the bottom of the screen to enter the file name. Tap the softkey marked “123@” to type numbers and special characters. The file name can include letters, numbers, spaces, and a limited selection of special characters. Note that the maximum length is 40 characters.

(For typing shortcuts and additional options, see **Using the X Name Softkeys** below.)

Using the X Name Softkeys

The **X Name Page 1** and **X Name Page 2** softkeys open a selection of customizable keys for naming files. If the user must frequently save files about antenna use, the “Antenna” key on X Name Page 1 will enter the entire word at once. Use these keys to save time while conducting field operations.

To customize your X Name softkeys, simply open X Name Page 1 or 2 and tap **Rename Keys** on the right side of the display. Choose a key to rename, and type your desired entry with the touchscreen keyboard. Then tap Done to save it and **Finish** to exit.

Toggle Separator **On** or **Off** to automatically insert a dash (“-”) or underscore (“_”) between words, e.g. “loadsystem” vs. “load_system”.

34.2.2 File Types

The file type bar contains two buttons: **Setup** and **Image**. Select the type of file you wish to save by tapping a button; your current selection will be highlighted green.



- Setup files - configurations of the current measurement mode of the instrument, frequency and distance parameters, marker placement, etc..
NOTE: By using configuration files wisely, the user can restore the instrument to a previous state. This feature reduces time spent repeating setup and calibration steps.
- Measurement - measurement data, readable by compatible software. See below for formats.
- Image files - screenshots of the display at the time the ScrnShot key was pressed.

File Extensions

The table below lists the various types of files that can be saved. Each type of file has a different suffix, which will follow the filename you enter. (For example, an image named “my_measurement” will be saved as “my_measurement.bmp”.)

File Type	Suffix
Measurement file – VSMR	.SWR
Measurement file – return loss	.RTL
Measurement file – cable loss	.CBL
Measurement file – DTF-VSWR	.DVS
Measurement file – DTF-return loss	.DRL
Measurement file – fiber scope	.FMI

File Type	Suffix
Measurement file – phase	.PHA
Measurement file – Smith Chart	.SMI
Measurement file – power meter	.PMM
Setup file	.STP
Image file	.BMP

34.2.3 Location

The file location bar contains two buttons: **Local Disk** and **USB Disk**. Select where you wish to save the file by tapping a button; your current selection will be highlighted green.

Location:**Local Disk****USB Disk**

- Local Disk – file will be saved to the instrument’s internal memory.
- USB Disk – file will be saved to the currently connected USB device. Must have a USB memory stick inserted into the USB Type-A connector on the instrument’s top panel.

Once you have successfully determined the filename, type, and location, press the **Save** softkey on the right side of the **File Save** menu to finish.

34.3 Managing Files

Access the **File Manager** screen by pressing the **File** (#1) key on the data keypad. From this screen, you may view the system configurations, measurement data, images, and other files currently saved to the instrument or a connected USB device.

You can organize, move, or delete these files as desired.

34.3.1 Viewing files

Like the **File Save** screen (see section 34.2), the File Manager screen has fields for file name, file type, and location. Here, they are best navigated in reverse order: first **Location**, then **Type**, then **Filename**.

Location

Contains two softkeys: Local Disk and USB Disk. Tap a softkey to choose which disk to read files on: the instrument’s internal memory or a connected USB device.

Type

Contains five softkeys:

- **Setup:** Setup configuration files can include active measurement mode of the instrument, frequency/distance, marker placement, and other parameters and calibration data.
- **Meas:** Measurement files contain all information in the current field and the measurement data.
- **Trace:** Trace files contain saved measurement traces.
- **Report:** Report files contain reports based on collected trace data. Reports can be generated using the Saluki Site Workbench Software; please see Chapter 36 - Software Tools for more information.
- **Image:** The ScrnShot function saves a screenshot of the current display and saves it as an image. The image can be previewed from the instrument using the Preview softkey in the top right-hand corner of the File Manager display.

Tap a softkey to view all the files of that type stored on the disk.

File Name

Displays the currently selected file’s name.

The files meeting your specifications will appear in the list below these fields. Tap a file’s name to select it for

further action. You can also rearrange files, using the instrument’s navigation tools (see subsection 34.3.3) or the sortbar that runs horizontally above the file list. The sortbar contains headers such as file name, size, and save date (when the file was created or modified). Use these headers to change the order of the file list based on alphabetical order, age, etc.

For example, tap “File Size” once and an up-arrow will appear. This indicates that your files are now being displayed according to size, from smallest to largest. Tap the key again to reverse the order and display from largest to smallest.

Each file is listed with a checkbox icon under the column marked **Selected**. You can check multiple boxes in order to select many files at once. (You cannot read/preview more than one file at a time.) Check the box next to “Selected” to select all files in the list.

34.3.2 Manager tools

When you have selected one or more files, the **Manager** submenu opens. This menu lists management options for your files. They are detailed below.

 Manager	Read/Preview: Loads selected files from internal memory. Images can be previewed to display them on the instrument’s display. Use the Preview submenu (shown below) to navigate through images, or tap Full Screen to expand the image for better viewing.
Read	
Delete	Delete: Erases selected files from the disk.
Refresh	Refresh: Updates the file list to reflect all recent changes to stored data.
Export To USB Disk	Export to USB Disk / Import to Local Disk: Moves selected files from the instrument’s internal memory to a connected USB storage device, or vice-versa.

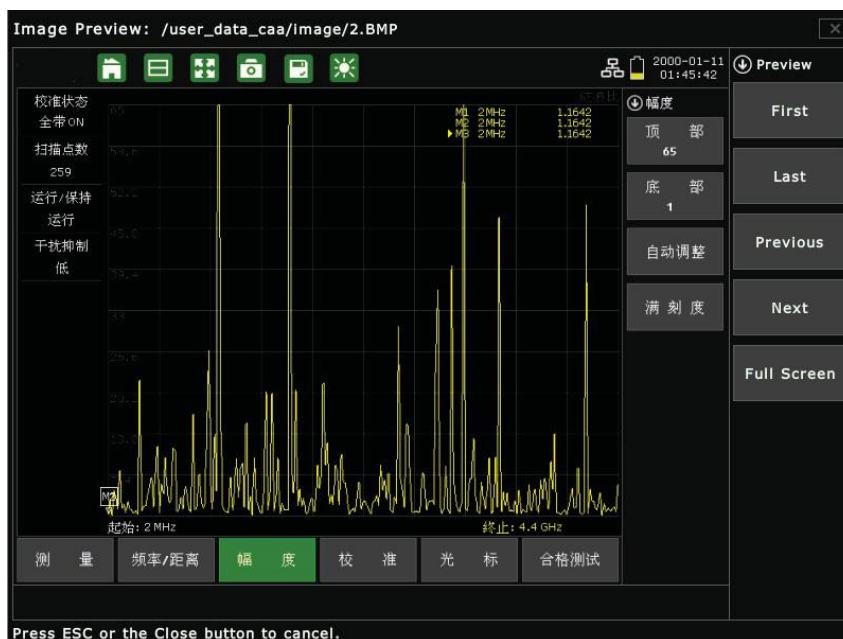

Fig.34.3 Previewing a saved screenshot

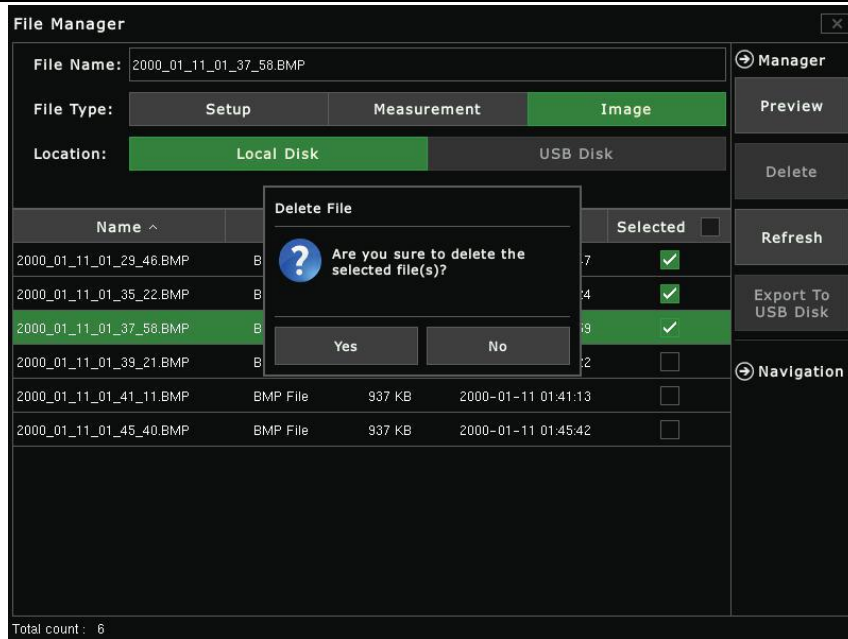



Fig.34.4 Making multiple items for deletion

34.3.3 Navigation tools

Under the **Manager** submenu key, tap the **Navigation** submenu key to open the Navigation submenu. These tools enable you to quickly sift through long lists of saved files. They are detailed below.

	Top: Selects the first file listed.
	Bottom: Selects the last file listed.
	Page Up: Scrolls to previous page of files.
	Page Down: Scrolls to next page of files.

Chapter 35 System Operations

Introduction

This chapter provides an overview of the S5700 series analyzer’s system operations, including:

- System configuration
- Service operations
- Display language
- Date/time setup
- Network setup
- System testing
- System information
- System update

The system menu contains system setup options, information about the instrument, system upgrade functions, and the help menu. When the user selects a function by tapping it, it will open a sub-menu for the user to set parameters or make other edits.

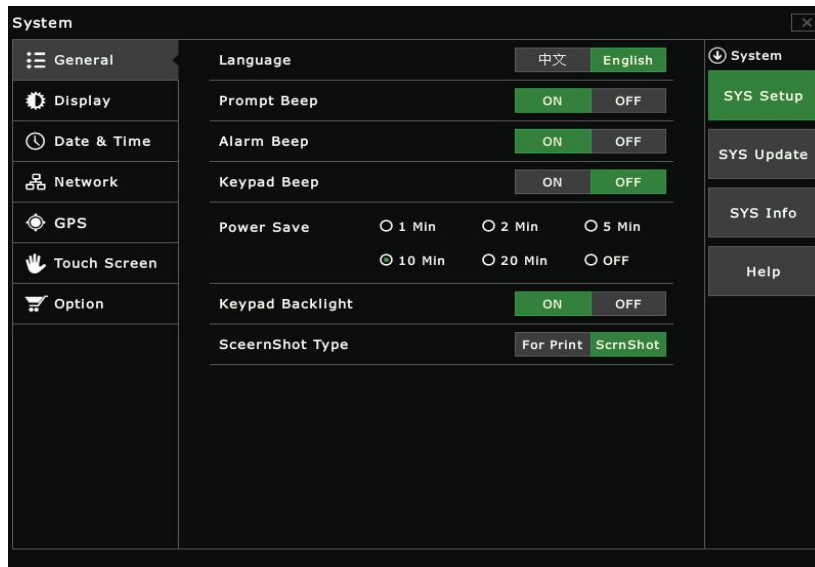



Fig.35.1 General settings

Press the **System** (# 8) data key to enter the main system menu. Its functions are detailed below.

System	SYS Setup: Opens the “Setup” submenu. See Section 35.1 for details.
SYS Setup	SYS Update: Opens the “Update” submenu. See Section 35.2 for details.
SYS Update	SYS Info: Opens the “System Information” submenu. See Section 35.3 for details.
SYS Info	Help: Opens System Help. See Section 35.4 for details.
Help	

35.1 System Setup

 <ul style="list-style-type: none"> General Display Date & Time Network GPS Touch Screen Option 	<p>General: View and change general system settings.</p> <p>Display: Change display brightness and color scheme, and toggle visual measurement aids on or off.</p> <p>Date & Time: View and update the system’s internal clock.</p> <p>Network: Change the system’s networking settings.</p> <p>GPS: Enable or test the instrument’s GPS functionality.</p> <p>Touch Screen: Re-calibrate the instrument’s touchscreen.</p> <p>Options: Enter serial numbers for optional features that the user has purchased.</p>
---	--

35.1.1 General System Settings

Within the **System** menu, tap the **General** softkey to open the general settings submenu.

Language

Tap to highlight English or Chinese as your preferred language. All system text will appear in the language of your choice.

Prompt Beep

For the completion of some specific actions, the system will issue a short beep to prompt the user.

Alarm Beep

The system will issue an alert beep if an invalid value is entered.

Power Save / Keypad Backlight

To conserve battery power, you may choose to have the instrument’s display automatically dim if no input is made after a given period of time. If you turn OFF the power-save option, the screen will remain bright as long as the instrument is on. The data keypad backlight can also be toggled ON or OFF.

ScrnShot Type

The instrument can capture screenshots in a color-edited form optimized for printing. Select “For Print” to take screenshots with dark text on white background, or “Scrnshot” for white text on dark background.

35.1.2 Display

Brightness

Tap an option (5%, 25%, 50%, 75%, or 100%) to adjust the brightness of the display backlight.

Sweep Line

Toggle the sweep line feature ON or OFF.

Grid

Toggle the gray measurement grid ON or OFF.

Prompt

Toggle the entry prompt ON or OFF.

35.1.3 Date and Time

Date

Set the day, month, and year of the instrument’s internal clock. Tap the entry field and use the touchscreen keyboard, data keypad, Up/Down arrow keys, or rotary knob to enter the current date.

Date Format

Determine the order in which the day, month, and year are displayed.

Time

Set the hour, minute, and second of the instrument’s internal clock. Tap the entry field and use the touchscreen keyboard, data keypad, Up/Down arrow keys, or rotary knob to enter the current time.

Time Format

Determine whether to display the current time on a 12-hour or 24-hour rotation (e.g., 7:00 pm or 19:00).

Time Zone

Adjust the system clock by selecting your current time zone and Daylight Savings Time setting. Press Enter to save your changes.

35.1.4 Network



Fig.35.2 Network overview

In the Network submenu, you will find options for setting network communication information. Enter the IP address at the bottom of the screen, using the data keypad. Press the Enter key to complete the setup. At this time, the instrument’s default IP address is 192.168.0.138.

35.1.5 GPS

GPS Enable

Toggle the instrument's Global Positioning System functions ON or OFF.

GPS Test

Tap Start to begin a brief test to determine if the GPS is functioning correctly. If no location information is received, three gray horizontal lines will be displayed (“---”). Verify that the GPS antenna can access all necessary equipment, and that the outdoor antenna is not obstructed by other objects.

35.1.6 Touch Screen

Calibrate

Calibrate the touchscreen if the user's input / softkey taps are not properly registered. Tap **Start** and follow the on-screen instructions to re-calibrate the touch screen. Use the included touchscreen stylus for the most accurate results.

After the calibration procedure, press Enter to accept the recalibration or Esc to cancel.

Cursor

When this option is toggled ON, the instrument will display a pointer arrow (cursor) that can be used to indicate a softkey selection instead of tapping. Move the cursor with the directional arrow keys above the keypad, and press Enter to “click” the desired softkey. When a message box is displayed, the left or right arrows keys can be used to make a selection.

NOTE: When the cursor is enabled, the Enter key is used exclusively for activating the cursor mouse-up / mouse-down key functions. All other Enter key functions are disabled

35.1.7 Option

Enter keys	FF1DB6B416B1A0E16CE445D570C060F3AC2F830CC E4B76932BFFCD847022C18F 38BCE4F4BCF6425A631FE612DEF413F4A13C60DCE6 019B8708E0C8E8E2749725T
Load	Enter
Note: Press the Load button to load keys from keys.txt at the root path of the USB Disk.	

The instrument can be configured with additional measurement modes at the time of purchase, or at a later date in the field, as your test needs evolve. These software-enabled product measurement options can be added to the instrument in the **Option** submenu.

In order to enable your additional product options, you will need the serial number you received upon purchasing the option. There are two ways to enter this number:

- In the Option submenu, tap the large entry field. Use the touchscreen keyboard to type the serial number of your option. Tap the softkey marked **Enter** to confirm.
- Using the Type-A USB connector on the instrument's top panel, connect a USB storage device containing the serial number. Then, tap the softkey marked **Load**.

35.2 System Update

On occasion, the S5700 series may require software updates provided by Saluki Instruments. Saluki will notify you when an updated version of the software is released.

To apply an update, first insert a USB memory stick containing the update data into the Type-A USB connector on the instrument's top panel. (Please ensure that the update folder is placed in the root [top-level] directory of the USB device).

Press the System (#8) data key to access the System menu, then tap the **SYS Update** softkey and press **Start**. Do not remove the USB device until the update is completed.

35.3 System Information

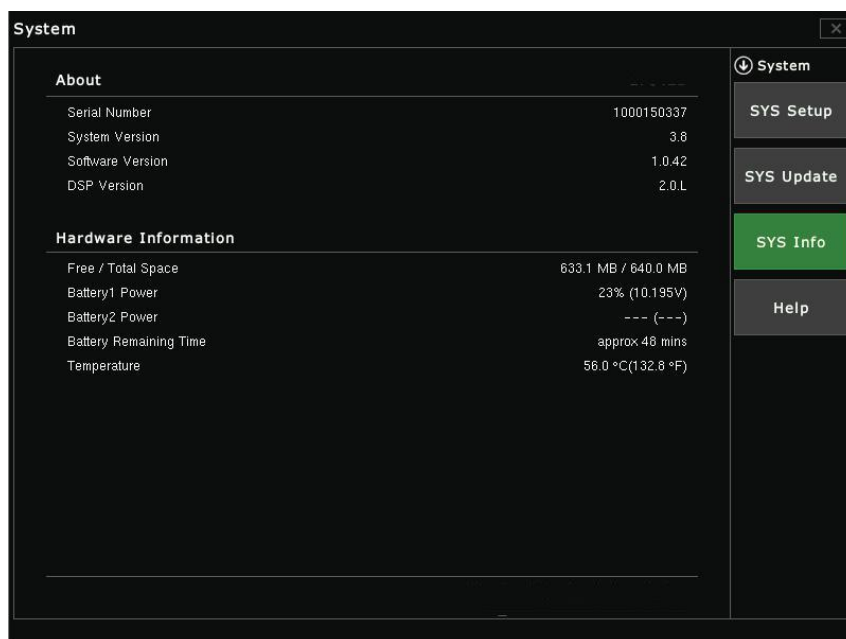

Fig.35.3 System information

The **SYS Info** screen displays information about the instrument's software and hardware, including:

- Device serial number
- Operating system version
- Software version
- DSP version
- Battery status
- Current internal temperature
- Available storage space in internal memory

Chapter 36 Software Tools

Introduction

This chapter provides an overview of the Site Workbench software. The software tools is a program for transferring and editing saved measurements, markers, and limit lines between a test-and-measurement device and a PC.

Site Workbench is compatible with Microsoft Windows 2000, Windows XP, and Windows 7 versions; it is not compatible with earlier versions of the Microsoft Windows operating system. For detailed information, please refer to the Site Workbench manual.

36.1 Feature Overview

Display and Analyze Traces

Site Workbench can read files saved by the measurement equipment. It can also display the measurement traces and analyze data. Site Workbench enables users to edit markers and limit lines from a PC - as well as changing the trace of the scale.

Context Menu

Access Site Workbench's context menus by right-clicking on an active measurement screen in the graphic display editor window. Among other functions, users can edit images from this menu.

Editor Features

The software includes a cable editor, the signal standard editor, and other commonly-used editing tools. You can upload and download data from the instrument as well.

Remote Control Software

Site Workbench's remote-access tools enable users to carry out test and measurement procedures remotely through their equipment.

Superimposed Trace

This feature allows the user to compare multiple measurement traces in the same view pane.

36.2 Installing Site Workbench

Site Workbench is provided on the CD-ROM included with the equipment. Insert the CD-ROM into a PC to run the installer. Follow the instructions on screen to install Site Workbench on your computer.

36.3 Connecting to the Field Comm Analyzer

Use a crossover network cable (included with the instrument) to connect to a PC via the following steps:

1. Plug the network cable into the network port in the instrument's top panel. Connect the other end to the network port on your PC.
2. Press the **ON/OFF** button on the instrument to power it on. Confirm the instrument's IP address.

-
- a. Press the **System** (#8) data key to open the System menu, then open the **Network** submenu.
 - b. Next to “IP Address”, the field should read 192.168.0.138. If it does not, re-enter the IP address.
3. On your PC, run the Site Workbench management software. When prompted, enter the IP address of the connected instrument.
 4. Press **Connect** to begin the connection.

Appendix A Creating GeoEmbedded Maps

Introduction

Most outdoor wireless communications systems are designed to provide coverage over a predetermined area. These systems must also not interfere with other cell sites using the same frequencies. When designing cell sites, coverage estimation software must make assumptions about loss due to terrain, buildings and other factors. Occasionally these assumptions are not accurate, or changes among various factors over time within the environment have resulted in the actual coverage differing from the design. Periodically mapping coverage with a precision receiver can help to provide proof that the coverage has deviated from the initial design and can also help separate interference issues from signal strength problems.

Point location measurements of spectrum analyzer displays are commonly used in outdoor signal coverage surveys to document signal levels. Spectrum analyzers provide accurate RF power measurements over a wide frequency range. When an antenna is attached to the spectrum analyzer, these measurements become **Received Signal Strength (RSSI)** measurements. In order to determine outdoor signal coverage, RSSI measurements can be combined with an on-screen map, making it a very effective solution for mapping signal coverage of RF transmitters.

The S5700 series field comm analyzer can be upgraded with option S5700-05, Signal Coverage Mapping. This option supports indoor and outdoor mapping applications.

In this application note, you will learn how to operate the S5700 series analyzer to make outdoor drive test signal coverage mapping measurements. Outdoor drive test mapping employs the use of GPS to synchronize with the instrument enabling the instrument to automatically plot the GPS location and signal level on the desired map area throughout the course of the drive test. Thus, the first step in the indoor mapping process is creating an indoor map.

Map Tools

Saluki Map Tools is a PC-based software program that enables a user to create a map file (.jmap file) that can be read and displayed by the analyzer. The Map Tools software is located on the CD provided with the instrument.

1. The first step in creating an outdoor map file (.jmap file) is to locate install the Saluki Map Tools software on your PC. Right click on the **setup.exe** file and select “Run as Administrator” to start the installation of Map Tools. Once the installation is complete, a desktop icon will be created.



2. Click on the **Map Tools** icon to start creating your drive test map. Once you click on the Map Tools icon, the software program will open showing a simple Map Tools configurator.

3. To begin the actual creation of your drive test map, select **Source** from the map source box located along the left edge of the Map Tools configurator. Map Tools supports both Google Maps and Open Street. The choice is up to you. To make a source selection, place your cursor on the source menu down-arrow and select either **Google** or **Open Street**.

4. Next, if selecting your source (Google Maps or Open Street) did not automatically open a list of server options, place your cursor over the server down arrow and select your **server option**.

5. Once the source and server selections have been made, a Google Map will automatically appear. To move the map so that it reflects your desired drive test range, drag the map left/right or up/down, zoom-in or zoom-out, until you have established your drive test area.

a. Ideally, you want to create a map that reflects your specific drive test needs – not your entire area code.

6. Upon optimizing the map to reflect your specific drive test needs, move your cursor and Select Range. This will highlight the map area to be created. If you are satisfied with the highlighted area, select **Load Range**.

7. Next, create a name for your drive test map in the Map Name box. Note: before you create your map, check to ensure that your zoom level has been set to levels 11, 13 and 15 (these are the default settings; under normal circumstances these settings should not be altered). Once you are satisfied with your highlighted map area, settings, etc. select Start.

8. Once the outdoor map (.jmap file) has been created, you will need to save the file to a USB flash drive to transfer the outdoor map file to the map manager (local drive).

Now, the map file is ready to be transferred to the S5700 series analyzer's map manager for an outdoor signal coverage survey. For step-by-step instructions, please continue with subsection 32.2.2.

Appendix B Creating non-GeoEmbedded Maps

Introduction

Most indoor wireless communications systems are designed to provide coverage over a predetermined area. Coverage estimation software must make assumptions about loss due to building design, materials and other factors. Occasionally buildings will undergo remodel for one reason or another without consideration to wireless coverage. Thus, facility managers often need to verify that Public Safety, Broadcast and Personal communication systems operate to specified levels throughout the facility.

Point location measurements of spectrum analyzer displays are commonly used in indoor signal coverage surveys to document signal levels. Spectrum analyzers provide accurate RF power measurements over a wide frequency range. When an antenna is attached to the spectrum analyzer these measurements become **Received Signal Strength** (RSSI) measurements. In order to determine indoor signal coverage, RSSI measurements can be combined with an on-screen map, making it a very effective solution for mapping signal coverage of RF transmitters.

The S5700 series field comm analyzer can be upgraded with option S5700-05, Signal Coverage Mapping. This option supports indoor and outdoor mapping applications.

In this application note, you will learn how to operate the S5700 series to make indoor signal coverage mapping measurements. Indoor mapping does not use GPS to determine current location due to the inability of the GPS signal to synchronize with the instrument when used in an indoor environment. Instead, the user must report the instrument's location with respect to the indoor map being displayed by the instrument. The analyzer employs a touchscreen user interface, making it easy to report locations of indoor measurements by just touching the on-screen indoor map. Thus, the first step in the indoor mapping process is creating an indoor map.

Indoor Map Converter

Saluki Map Tools (Indoor Map Converter) is a PC-based software program that enables a user to convert an indoor map picture file (JPEG, GIF, TIFF or PNG) to a map file (.mai file) that can be read and displayed by the analyzer. Saluki Indoor Map Converter is located on the CD provided with the instrument.

NOTE: The Indoor Map Converter is an entirely different software application than the Map Tools which is used for creating Google-based maps for outdoor drive test signal coverage mapping applications.

1. The first step in creating an indoor map file (.mai file) is to install the Saluki Map Tools software on your PC. Right click on the **setup.exe** file and select "Run as Administrator" to start the installation of Map Tools. Once the installation is complete, a desktop icon will be created: Indoor Map Converter.
2. Click on the **Indoor Map Converter** to start creating your convert your indoor floor plan image to a map file. Once you click on the Indoor Map Converter icon, the software program will open, showing a simple Indoor Map Converter configurator.
3. To begin the actual creation of your indoor map, select **Open Picture** from the map source box located along the left edge of the Indoor Map Converter. Presumably, your indoor map picture has been previously downloaded to

your PC pictures folder. Clicking on the Open Picture button will automatically open your PCs picture folder, wherein you will select the indoor map image (JPEG, GIF, TIFF or PNG) that you want to convert to an indoor map file.

4. Once the indoor map picture selection has been made from your pictures folder, it will automatically appear in the Indoor Map Converter window.

5. After the map picture has been loaded, you will need to select your **Length** option and a **filename**.

a. Generally, a length of 768 is considered a good starting point. This will allow you to scroll the map up/down, left/right for improved measurement resolution.

b. The new indoor map file name (.mai file) should reflect your map location, such as “450 Scott_Floor 2”.

NOTE: Level should be zero (0) for all map settings by default. If not, please correct.

6. Once you are satisfied with your map area, settings, etc. confirm that the **565-box** has been selected (✓), then select **Save Picture**.

Now, the map file is ready to be transferred to the Building Manager for an indoor signal coverage survey. For step-by-step instructions, please continue with subsection 32.1.2.

- End of Document -